

Introduction to
GeoGebra
Version 4.4

www.geogebra.org



Introduction to GeoGebra

Last modified: **November 23, 2013**

Written for GeoGebra 4.4

This book covers the basic introduction to the dynamic mathematics software GeoGebra. It can be used both for workshops and for self-learning.

Authors

This book was started by Judith & Markus Hohenwarter in 2008 and later revised and extended with help from many other GeoGebra Team members.

License / Copyright

International GeoGebra Institute, office@geogebra.org
Creative Commons Attribution-Noncommercial-Share Alike
see <http://creativecommons.org/licenses/by-nc-sa/3.0/>

You are free:

- **to Share** – to copy, distribute and transmit the work
- **to Remix** – to adapt the work

Under the following conditions:

- **Attribution.** You must attribute the work by mentioning the original authors and providing a link to www.geogebra.org (but not in any way that suggests that they endorse you or your use of the work).
- **Noncommercial.** You may not use this work for commercial purposes.
- **Share Alike.** If you alter, transform, or build upon this work, you may distribute the resulting work only under the same or similar license to this one.

Acknowledgments

This material is based upon work supported by the following grants. Any opinions, findings, and conclusions or recommendations expressed in this material are those of the author(s) and do not necessarily reflect the views of the supporting organizations.

- 2010-2013: State of Upper Austria "GeoGebra for Schools" Grant, Johannes Kepler University, Linz, Austria
- 2006-2008: National Science Foundation under Grant No. EHR-0412342, NSF Math and Science Partnership "Standards Mapped Graduate Education and Mentoring", Florida Atlantic University, Boca Raton, USA



How to Use this Book

“Introduction to GeoGebra” covers all basics of the dynamic mathematics software GeoGebra. On the one hand, this book can serve as a basis for introductory workshops guided by an experienced GeoGebra presenter. On the other hand, you can use this document to learn the use of the software yourself.

By working through this book you will learn about the use of GeoGebra for teaching and learning mathematics from middle school (age 10) up to college level. The provided sequence of activities introduces you to geometry tools, algebraic input, commands, and a selection of different GeoGebra features. Thereby, a variety of different mathematical topics is covered in order to familiarize you with the versatility of the software and to introduce you to some methods of integrating GeoGebra into your everyday teaching.

We wish you a lot of fun and success working with GeoGebra!
Judith, Markus, and the GeoGebra Team



Table of Contents

1. Introduction & Installation Drawings vs. Geometric Constructions .	7
1.1. Introduction and Installation of GeoGebra.....	8
1.2. Basic Use of GeoGebra	11
1.3. Creating drawings with GeoGebra	12
1.4. Drawings, Constructions, and Drag Test.....	13
1.5. Rectangle Construction	14
1.6. Navigation Bar and Construction Protocol.....	15
1.7. Equilateral Triangle Construction	16
1.8. GeoGebra's Properties Dialog	17
1.9. Challenge of the Day: Isosceles Triangle Construction.....	19
2. Geometric Constructions & Use of Commands	20
2.1. Square Construction	21
2.2. Regular Hexagon Construction	22
2.3. Circumscribed Circle of a Triangle Construction	23
2.4. Visualize the Theorem of Thales.....	25
2.5. Constructing Tangents to a Circle	26
2.6. Exploring Parameters of a Quadratic Polynomial.....	29
2.7. Using Sliders to Modify Parameters	30
2.8. Challenge of the Day: Parameters of Polynomials.....	32
3. Algebraic Input, Functions & Export of Pictures to the Clipboard.	33
3.1. Parameters of a Linear Equation.....	34
3.2. Library of Functions – Visualizing Absolute Values.....	36
3.3. Library of Functions – Superposition of Sine Waves.....	37
3.4. Introducing Derivatives – The Slope Function.....	38
3.5. Exploring Polynomials.....	40
3.6. Exporting a Picture to the Clipboard.....	40
3.7. Inserting Pictures into a Text Processing Document.....	42
3.8. Challenge of the Day: Creating Instructional Materials	43



4. Transformations & Inserting Pictures into the Graphics View	44
4.1. Creating a 'Function Domino' Game	45
4.2. Creating a 'Geometric Figures Memory' Game	46
4.3. Exploring Symmetry with GeoGebra	48
4.4. Resizing, Reflecting and Distorting a Picture	50
4.5. Exploring Properties of Reflection	52
4.6. Translating Pictures	53
4.7. Rotating Polygons	54
4.8. Challenge of the Day: Tiling with Regular Polygons.....	56
5. Inserting Static and Dynamic Text into the GeoGebra's Graphics View.....	59
5.1. Coordinates of Reflected Points.....	60
5.2. Inserting Text into the Graphics View.....	60
5.3. Visualizing a System of Linear Equations	62
5.4. Visualizing the Angle Sum in a Triangle.....	63
5.5. Constructing a Slope Triangle.....	65
5.6. Dynamic Fractions and Attaching Text to Objects.....	67
5.7. The mod 3 Clock.....	68
5.8. Challenge of the Day: Visualize a Binomial Formula.....	70
6. Creating and Enhancing Dynamic Worksheets with GeoGebra...	71
6.1. Introduction: The GeoGebraTube and User Forum.....	72
6.2. Lower and Upper Sum	74
6.3. Creating Dynamic Worksheets.....	75
6.4. Visualizing Triangle Inequalities	77
6.5. Design Guidelines for Dynamic Worksheets	79
6.6. Creating a 'Tangram' Puzzle	83
6.7. Challenge of the Day: Enhance Your 'Tangram' Puzzle	84
7. Custom Tools and Customizing the Toolbar	85
7.1. The Theorem of Pythagoras.....	86
7.2. Creating Custom Tools.....	88
7.3. Saving and Importing Custom Tools	90



7.4. Creating a Square Tool	91
7.5. The Fibonacci Spiral	92
7.6. Constructing the Center of a Circle	93
7.7. Customizing the Toolbar	95
7.8. Challenge of the Day: Euler's Discovery	96
8. Conditional Visibility & Sequences	100
8.1. Visualizing Integer Addition on the Number Line.....	101
8.2. Animating Constructions	103
8.3. Conditional Formatting – Inserting Checkboxes.....	105
8.4. The Sierpinski Triangle.....	107
8.5. Introducing Sequences.....	109
8.6. Visualizing Multiplication of Natural Numbers	110
8.7. Challenge of the Day: String Art Based on Bézier Curves	112
9. Spreadsheet View and Basic Statistics Concepts.....	114
9.1. Introduction to GeoGebra's Spreadsheet View	115
9.2. Record to Spreadsheet Feature	116
9.3. Relative Copy and Linear Equations	118
9.4. Investigating Number Patterns	120
9.5. Scatter Plot and Best Fit Line.....	124
9.6. Challenge of the Day: Explore Basic Statistics Commands	126
10. CAS View - Computer Algebra System & CAS Specific Commands	128
10.1. Introduction to GeoGebra's CAS View	129
10.2. Manipulating Equations	131
10.3. GCD and LCM.....	132
10.4. Intersecting Polynomial Function	134
10.5. Solving Exponential Equations.....	136
10.6. Solving Systems of Equations.....	138
10.7. Working with Matrices	139

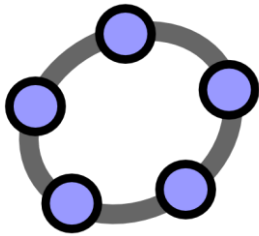

Introduction & Installation Drawings vs. Geometric Constructions

GeoGebra Workshop Handout 1



1. Introduction and Installation of GeoGebra

Background information about GeoGebra

GeoGebra is dynamic mathematics software for schools that joins geometry, algebra and calculus.

On the one hand, GeoGebra is an interactive geometry system. You can do constructions with points, vectors, segments, lines, polygons and conic sections as well as functions while changing them dynamically afterwards.

On the other hand, equations and coordinates can be entered directly. Thus, GeoGebra has the ability to deal with variables for numbers, vectors and points. It finds derivatives and integrals of functions and offers commands like *Root* or *Vertex*.

GeoGebra's user interface

After starting GeoGebra, the following window appears:

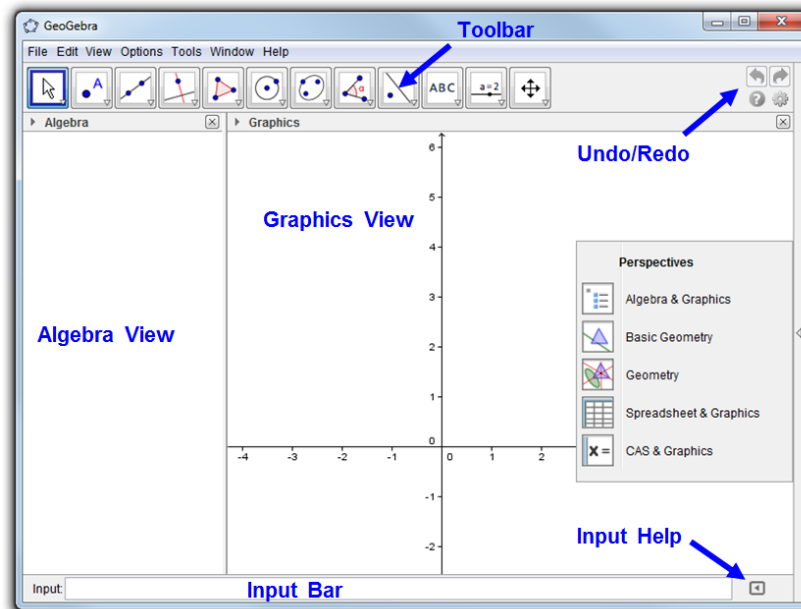

Using the provided geometry tools in the *Toolbar* you can create geometric constructions on the *Graphics View* with your mouse. At the same time the corresponding coordinates and equations are displayed in the *Algebra View*. On the other hand, you can directly enter algebraic input, commands, and functions into the *Input Bar* by using the keyboard. While the graphical representation of all objects is displayed in the *Graphics View*, their algebraic numeric representation is shown in the *Algebra View*. In GeoGebra, geometry and algebra work side by side.



The user interface of GeoGebra is flexible and can be adapted to the needs of your students. If you want to use GeoGebra in early middle school, you might want to work with a blank sheet in the *Graphics View* and geometry tools. Later on, you might want to introduce the coordinate system using a grid to facilitate working with integer coordinates. In high school, you might want to use algebraic input in order to guide your students through algebra on into calculus.

Apart from the *Graphics* and *Algebra View*, GeoGebra also offers a *Spreadsheet View*, a *Computer Algebra (CAS) View*, as well as a *second Graphics View*. These different views can be shown or hidden using the *View* menu. For quick access to several predefined user interface configuration, you may want to try the *Perspectives Sidebar* by clicking the bar to the right of the *Graphics View*.

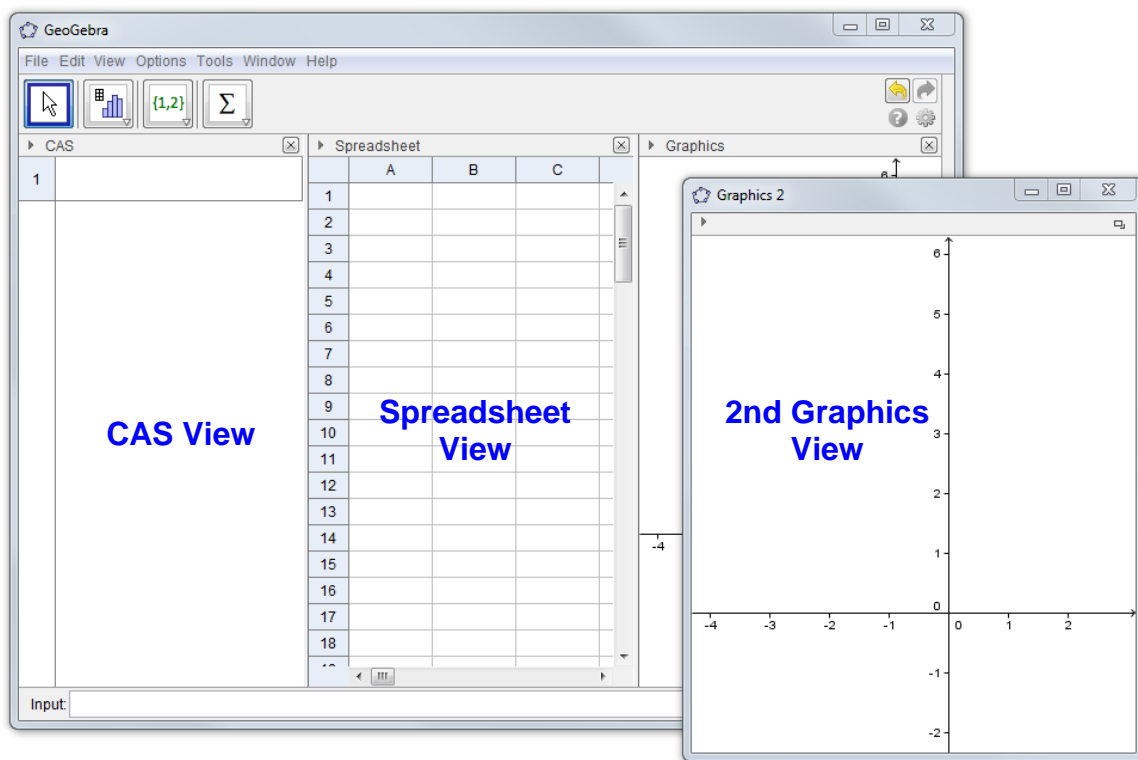



Installing GeoGebra

Preparations

Create a new folder called *GeoGebra_Introduction* on your desktop.

Hint: During the workshop, save all files into this folder so they are easy to find later on.

GeoGebra Installers

- Download the installer file from www.geogebra.org/download into the created *GeoGebra_Introduction* folder on your computer.
Hint: Make sure you have the correct version for your operating system.
- Double-click the GeoGebra installer file and follow the instructions of the installer assistant.



2. Basic Use of GeoGebra

How to operate GeoGebra's geometry tools

- Activate a tool by clicking on the button showing the corresponding icon.
- Open a toolbox by clicking on the lower part of a button and select another tool from this toolbox.

Hint: You don't have to open the toolbox every time you want to select a tool. If the icon of the desired tool is already shown on the button it can be activated directly.

Hint: Toolboxes contain similar tools or tools that generate the same type of new object.

- Click on the  icon at the right of the Toolbar to get help on the currently active tool.

How to save and open GeoGebra files



Saving GeoGebra Files

- Open the *File* menu and select  *Save*.
- Select the folder *GeoGebra_Introduction* in the appearing dialog window.
- Type in a *name* for your GeoGebra file.
- Click *Save* in order to finish this process.

Hint: A file with the extension '*.ggb*' is created. This extension identifies GeoGebra files and indicates that they can only be opened with GeoGebra.

Hint: Name your files properly: Avoid using spaces or special symbols in a file name since they can cause unnecessary problems when transferred to other computers. Instead you can use underscores or upper case letters within the file name (e.g. *First_Drawing.ggb*).

Opening GeoGebra Files



- Open a **new GeoGebra window** (menu *File* –  *New window*).
- Open a **blank GeoGebra interface** within the **same window** (menu *File* – *New*).
- Open an **already existing GeoGebra file** (menu *File* –  *Open*).
 - Navigate through the folder structure in the appearing window.
 - Select a GeoGebra file (extension '*.ggb*') and click *Open*.

Hint: If you didn't save the existing construction yet GeoGebra will ask you to do so before the blank screen / new file is opened.



3. Creating drawings with GeoGebra





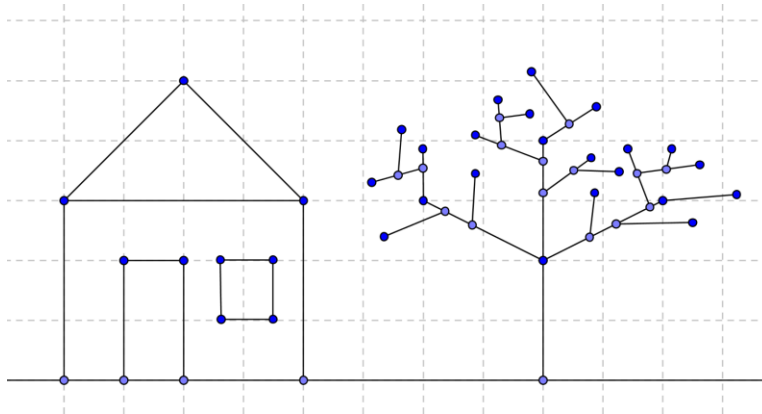



Preparations

- Click on the arrow at the right side of the *Graphics View* and select  *Basic Geometry* from the *Perspectives Sidebar*.
- Right-click (MacOS: *Ctrl*-click) on the *Graphics View* and choose  *Grid* to show the grid lines



Drawing Pictures with GeoGebra

Use the mouse and the following selection of tools in order to draw figures in the *Graphics View* (e.g. square, rectangle, house, tree,...).

	Point <i>Hint:</i> Click on the <i>Graphics View</i> or an already existing object to create a new point.	New!
	Move <i>Hint:</i> Drag a free object with the mouse.	New!
	Line <i>Hint:</i> Click on the <i>Graphics View</i> twice or on two already existing points.	New!
	Segment <i>Hint:</i> Click on the <i>Graphics View</i> twice or on two already existing points.	New!
	Delete <i>Hint:</i> Click on an object to delete it.	New!
	Undo / Redo <i>Hint:</i> Undo / redo a construction step by step (on the right side of the Toolbar).	New!
	Move Graphics View <i>Hint:</i> Click and drag the <i>Graphics View</i> to change the visible part.	New!
	Zoom In / Zoom Out <i>Hint:</i> Click on the <i>Graphics View</i> to zoom in / out.	New!

Hint: Move the mouse over a tool to show a tooltip on how to use the tool.



What to practice

- How to select an already existing object.
Hint: When the pointer hovers above an object it highlights and the pointer changes its shape from a cross to an arrow. Clicking selects the corresponding object.
- How to create a point that lies on an object.
Hint: The point is displayed in a light blue color. Always check if the point really lies on the object by dragging it with the mouse (*Move* tool).
- How to correct mistakes step-by-step using the *Undo* and *Redo* buttons.

Note: Several tools allow the creation of points “on the fly”. This means that no existing objects are required in order to use the tool.

Example: The tool *Segment* can be applied to two already existing points or to the empty *Graphics View*. By clicking on the *Graphics View* the corresponding points are created and a segment is drawn in between them.

4. Drawings, Constructions, and Drag Test

Open the link to the dynamic worksheet “Squares, Squares, Squares...”
<http://www.geogebraTube.org/student/m25902>.

The dynamic figure shows several squares constructed in different ways.

- Examine the squares by dragging ALL their vertices with the mouse.
- Find out which of the quadrilaterals are real squares and which ones just happen to look like squares.
- Try to come up with a conjecture about how each square was created.
- Write down your conjectures on paper.

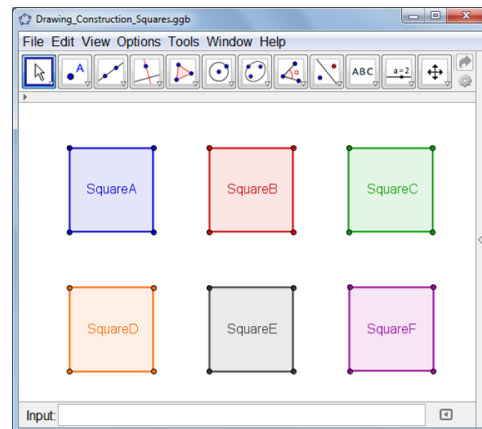

Discussion

- What is the difference between a drawing and a construction?
- What is the “drag test” and why is it important?
- Why is it important to construct figures instead of just drawing them in interactive geometry software?
- What do we have to know about the geometric figure before we are able to construct it using dynamic mathematics software?



5. Rectangle Construction



Preparations

- Summarize the properties of a rectangle before you start the construction.
Hint: If you don't know the construction steps necessary for a rectangle you might want to open the link to the dynamic worksheet "Rectangle Construction"



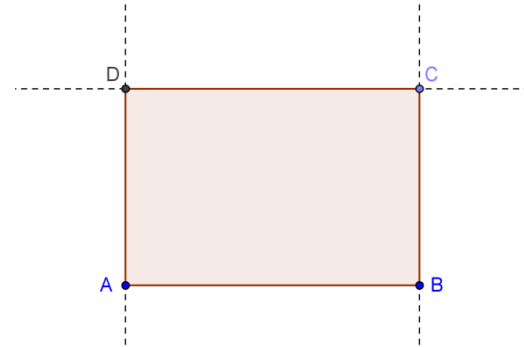

<http://www.geogebraTube.org/student/m>

[25907](http://www.geogebraTube.org/student/m/25907). Use the buttons of the *Navigation Bar* in order to replay the construction steps.

- Open a new GeoGebra window.
- Switch to *Perspectives* -  *Basic Geometry*.
- Change the labeling setting to *New Points Only* (menu *Options* – *Labeling*).





Introduction of new tools

	Perpendicular Line	New!
	<u>Hint</u> : Click on an already existing line and a point in order to create a perpendicular line through this point.	
	Parallel Line	New!
	<u>Hint</u> : Click on an already existing line and a point in order to create a parallel line through this point.	
	Intersect	New!
	<u>Hint</u> : Click on the intersection point of two objects to get this one intersection point. Successively click on both objects to get all intersection points.	
	Polygon	New!
	<u>Hints</u> : Click on the <i>Graphics View</i> or already existing points in order to create the vertices of a polygon. Connect the last and first vertex to close the polygon! Always connect vertices counterclockwise!	

Hints: Don't forget to read the *Toolbar help* if you don't know how to use a tool. Try out all new tools before you start the construction.

Construction Steps

1		Create segment AB .
2		Create a perpendicular line to segment AB through point B .



3		Insert a new point C on the perpendicular line.
4		Construct a parallel line to segment AB through point C .
5		Create a perpendicular line to segment AB through point A .
6		Construct intersection point D .
7		Create the polygon $ABCD$. <u>Hint:</u> To close the polygon click on the first vertex again.
8		Save the construction.
9		Apply the drag test to check if the construction is correct.

6. Navigation Bar and Construction Protocol

Right-click (MacOS: *Ctrl*-click) the Graphics View to show the *Navigation Bar* to review your construction step-by-step using its buttons.



In addition, you can open the *Construction Protocol* (View menu) to get detailed information about your construction steps.

What to practice

- Try to change the order of some construction steps by dragging a line with the mouse. Why does this NOT always work?
- Group several constructions steps by setting breakpoints:
 - Show the column *Breakpoint* by checking *Breakpoint* in the *Column* drop-down menu
 - Group construction steps by checking the *Breakpoint* box of the last one of the group.
 - Change setting to *Show Only Breakpoints* in the *Options* drop-down menu
 - Use the *Navigation Bar* to review the construction step-by-step. Did you set the breakpoints correctly?

No.	Name	Tool...	Definition	Value	Caption
1	Point A		Intersection point of xAxis, yAxis	A = (0, 0)	
2	Point B		Point on xAxis	B = (4, 0)	
3	Segment a		Segment [A, B]	a = 4	
4	Line b		Line through B perpendicular to a	b: x = 4	
5	Point C		Point on b	C = (4, 2.3)	
6	Line c		Line through C parallel to a	c: y = 2.3	
7	Line d		Line through A perpendicular to a	d: x = 0	
8	Point D		Intersection point of c, d	D = (0, 2.3)	
9	Quadrilate...		Polygon A, B, C, D	poly1 = 9.2	



7. Equilateral Triangle Construction



Preparations

- Summarize the properties of an equilateral triangle before you start the construction.

Hint: If you don't know the construction steps necessary for an equilateral triangle you might want to have a look at the following link to the dynamic worksheet "Equilateral Triangle Construction"



<http://www.geogebraTube.org/student/m25909>.

Use the buttons of the *Navigation Bar* in order to replay the construction steps.

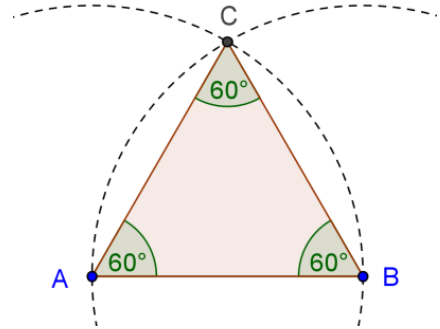
- Open a new GeoGebra window.
- Switch to *Perspectives* -  *Geometry*.
- Change the labeling setting to *New Points Only* (menu *Options* – *Labeling*).







Introduction of new tools

	Circle with Center through Point New! <u>Hint:</u> First click creates center, second click determines radius of the circle.
	Show / Hide Object New! <u>Hints:</u> Highlight all objects that should be hidden, then switch to another tool in order to apply the visibility changes!
	Angle New! <u>Hint:</u> Click on the points in counterclockwise direction! GeoGebra always creates angles with mathematically positive orientation.

Hints: Don't forget to read the Toolbar help if you don't know how to use a tool. Try out all new tools before you start the construction.

Construction Steps

1		Create segment AB .
2		Construct a circle with center A through B . <u>Hint:</u> Drag points A and B to check if the circle is connected to them.
3		Construct a circle with center B through A .
4		Intersect both circles to get point C .



5		Create the polygon ABC in counterclockwise direction.
6		Hide the two circles.
7		Show the interior angles of the triangle by clicking somewhere inside the triangle. <u>Hint</u> : Clockwise creation of the polygon gives you the exterior angles!
8		Save the construction.
9		Apply the drag test to check if the construction is correct.

8. GeoGebra's Object Properties

Graphics View Stylebar

You can find a button showing a small arrow to toggle the *Stylebar* in the upper left corner of the *Graphics View*. Depending on the currently selected tool or objects, the *Stylebar* shows different options to change the color, size, and style of objects in your construction. In the screenshot below, you see options to show or hide the *axes* and the *grid*, adapt *point capturing*, set the *color*, *point style*, etc.

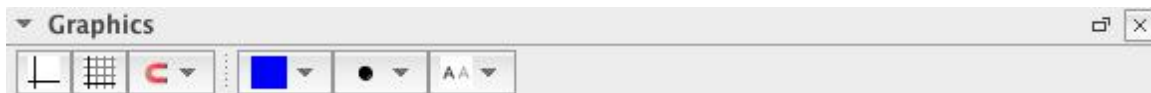

Hint: Each view has its own *Stylebar*. To toggle it, just click on the arrow in the upper left corner of the view.

Object Preferences Dialog

For more object properties you can use the *Preferences* dialog. You can access it in different ways:

- Click on the symbol on the right side of the Toolbar. Then choose *Objects* from the appearing menu.
- Right-click (MacOS: *Ctrl*-click) an object and select *Object Properties...*
- In the *Edit* menu at the top select *Object Properties...*
- Select the *Move* tool and double-click on an object in the *Graphics View*. In the appearing *Redefine* dialog, click on the button *Object Properties*.

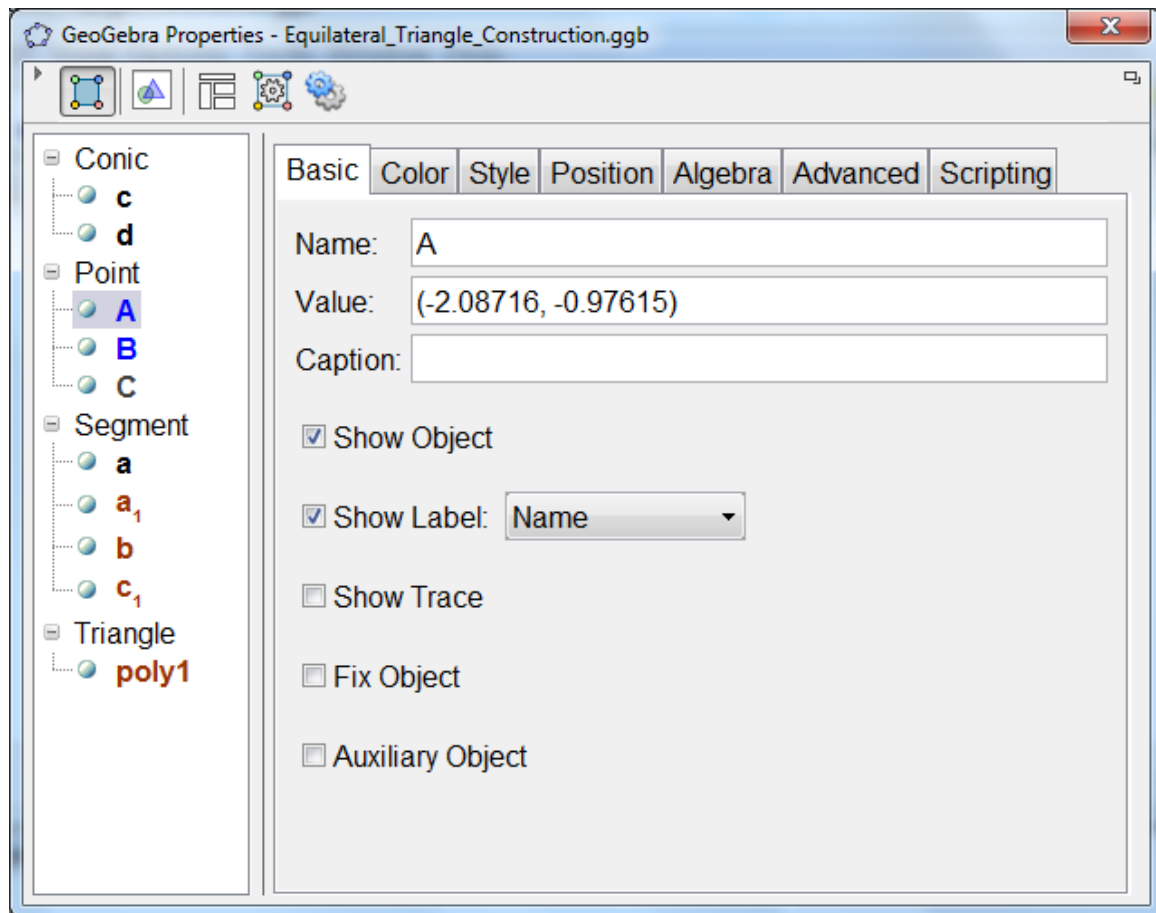

What to practice







- Select different objects from the list on the left hand side and explore the available properties tabs for different types of objects.
- Select several objects in order to change a certain property for all of them at the same time.
Hint: Hold the *Ctrl*-key (MacOS: *Cmd*-key) pressed and select all desired objects.
- Select all objects of one type by clicking on the corresponding heading.
- Show the value of different objects and try out different label styles.
- Change the default properties of certain objects (e.g. color, style,...).



9. Challenge of the Day: Isosceles Triangle Construction

Construct an isosceles triangle whose length of the base and height can be modified by dragging corresponding vertices with the mouse.

You will need the following tools in order to solve this challenge:

	Segment			Point
	Midpoint or Center	New!		Polygon
	Perpendicular Line			Move

Hints: Don't forget to read the Toolbar help if you don't know how to use a tool. Try out all new tools before you start the construction.

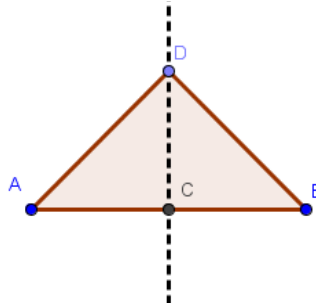

Tips and Tricks

- Summarize the properties of the geometric figure you want to create.
- Try to find out which GeoGebra tools can be used in order to construct the figure using some of these properties (e.g. right angle – tool *Perpendicular Line*).
- Make sure, you know how to use each tool before you begin the construction. If you don't know how to operate a certain tool, activate it and read the Toolbar help.
- For the activity open a new GeoGebra window and switch to *Perspectives - Geometry*.
- You might want to save your files before you start a new activity.
- Don't forget about the *Undo* and *Redo* buttons in case you make a mistake.
- Frequently use the *Move* tool in order to check your construction (e.g. are objects really connected, did you create any unnecessary objects).
- If you have questions, please ask a colleague before you address the presenter or assistant(s).

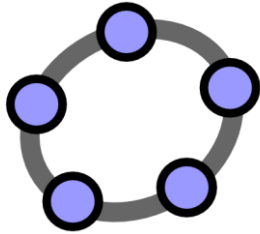

Geometric Constructions & Use of Commands

GeoGebra Workshop Handout 2



1. Square Construction

In this section you are going to use the following tools. Make sure you know how to use each tool before you begin with the actual construction of the square:

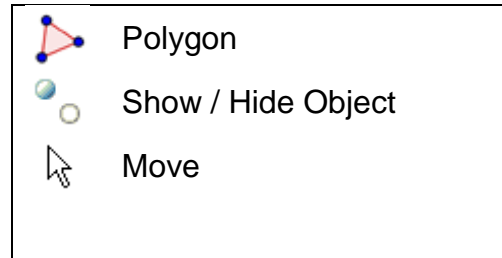
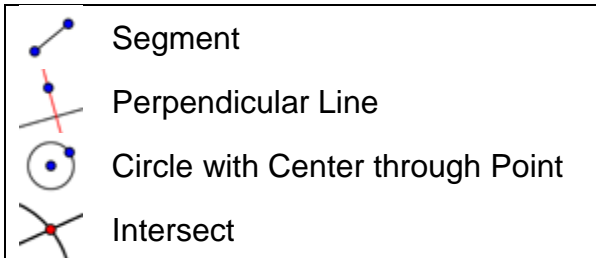

Hint: You might want to have a look at the link to the dynamic worksheet “Square Construction” <http://www.geogebraTube.org/student/m25910> if you are not sure about the construction steps.

Preparations

- Open a new GeoGebra window.
- Switch to *Perspectives* – *Geometry*.
- Change the labeling setting to *New Points Only* (menu *Options* – *Labeling*).

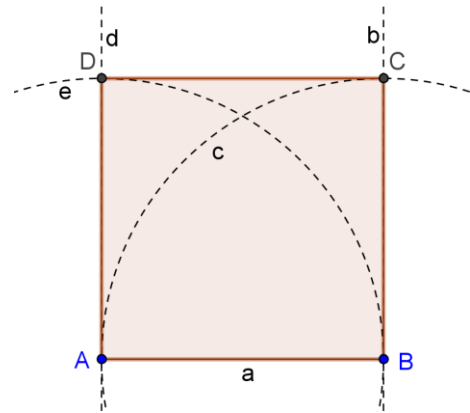

Construction Steps

1		Draw the segment $a = AB$ between points A and B .
2		Construct a perpendicular line b to segment AB through point B .
3		Construct a circle c with center B through point A .
4		Intersect the perpendicular line b with the circle c to get the intersection points C and D .
5		Construct a perpendicular line d to segment AB through point A .
6		Construct a circle e with center A through point B .
7		Intersect the perpendicular line d with the circle e to get the intersection points E and F .
8		Create the polygon $ABCE$. <u>Hint:</u> Don't forget to close the polygon by clicking on point A after selecting point E .



9		Hide circles and perpendicular lines.
10		Perform the drag test to check if your construction is correct.
11		Enhance your construction using the <i>Stylebar</i> .

Challenge: Can you come up with a different way of constructing a square?

Hint: To rename an object quickly, click on it in *Move* mode and start typing the new name on the keyboard to open the *Rename* dialog.

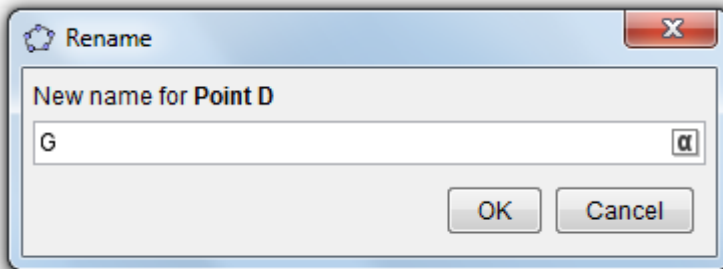

2. Regular Hexagon Construction



In this section you are going to use the following tools. Make sure you know how to use each tool before you begin with the actual construction of the hexagon:

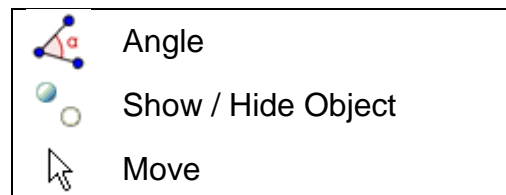
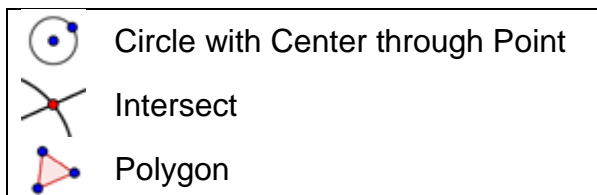

Hint: You might want to have a look at the link to the dynamic worksheet “Regular Hexagon Construction” <http://www.geogebraTube.org/student/m25912> if you are not sure about the construction steps.

Preparations

- Open a new GeoGebra window.
- Switch to *Perspectives* – *Geometry*.
- Change the labeling setting to *All New Objects* (menu *Options* – *Labeling*).

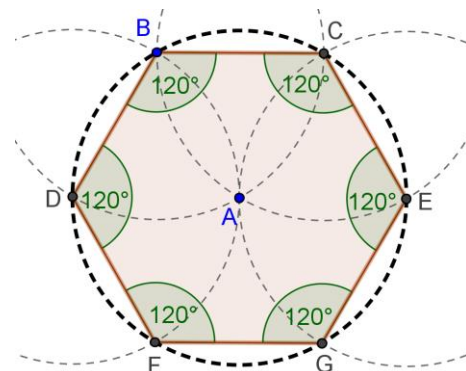



Construction Steps

1		Draw a circle c with center A through point B .
2		Construct a new circle d with center B through point A .
3		Intersect the circles c and d to get the hexagon's vertices C and D .
4		Construct a new circle e with center C through point A .
5		Intersect the new circle e with circle c in order to get vertex E . <u>Hint:</u> Selecting circle e and circle c creates both intersection points. If you just want a single intersection point, click on the intersection of the two circles directly.
6		Construct a new circle f with center D through point A .
7		Intersect the new circle f with circle c in order to get vertex F .
8		Construct a new circle g with center E through point A .
9		Intersect the new circle g with circle c in order to get vertex G .
10		Draw hexagon $FGECBD$.
11		Hide the circles.
12		Display the interior angles of the hexagon.
13		Perform the drag test to check if your construction is correct.

Challenge: Try to find an explanation for this construction process.

Hint: Which radius do the circles have and why?

3. Circumcircle of a Triangle Construction



In this section you are going to use the following tools. Make sure you know how to use each tool before you begin with the actual construction:

	Polygon
	Perpendicular Bisector New!
	Intersect

	Circle With Center through Point
	Move



Hint: If you are not sure about the construction steps, you might want to have a look at the link to the dynamic worksheet “Circumcircle of a Triangle Construction” <http://www.geogebraTube.org/student/m25916>.

Preparations

- Open a new GeoGebra window.
- Switch to *Perspectives* –  *Geometry*.
- Change the labeling setting to *New Points Only* (menu *Options* – *Labeling*).

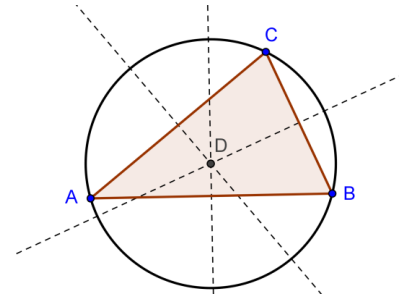



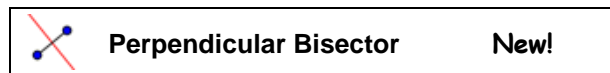

Introduction of new tool



Hints: Don't forget to read the Toolbar help if you don't know how to use the tool. Try out the new tool before you start the construction.

Construction Steps

1		Create an arbitrary triangle ABC .
2		Construct the perpendicular bisector for each side of the triangle. Hint: The tool <i>Perpendicular Bisector</i> can be applied to an existing segment.
3		Create intersection point D of two of the line bisectors. Hint: The tool <i>Intersect</i> can't be applied to the intersection of three lines. Either select two of the three line bisectors successively, or click on the intersection point and select one line at a time from the appearing list of objects in this position.
4		Construct a circle with center D through one of the vertices of triangle ABC .
5		Perform the drag test to check if your construction is correct.

Back to school...

Modify your construction to answer the following questions:

1. Can the circumcenter of a triangle lie outside the triangle? If yes, for which types of triangles is this true?
2. Try to find an explanation for using line bisectors in order to create the circumcenter of a triangle.



4. Visualize the Theorem of Thales



Back to school...

Before you begin this construction, check out the link to the dynamic worksheet called “Theorem of Thales” <http://www.geogebraTube.org/student/m25919> in order to see how students could rediscover what the Greek philosopher and mathematician Thales found out about 2600 years ago.

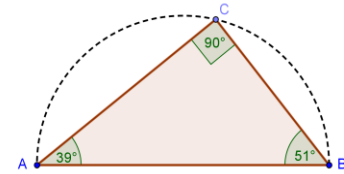

Greek philosopher and

In this activity you are going to use the following tools. Make sure you know how to use each tool before you begin with the actual construction:

	Segment	
	Semicircle through 2 Points	New!
	Point	

	Polygon
	Angle
	Move

Hint: If you are not sure about the construction steps, you might want to have a look at the link to the dynamic worksheet “Theorem of Thales Construction” <http://www.geogebraTube.org/student/m27291>.

Preparations

- Open a new GeoGebra window.
- Switch to *Perspectives* – *Geometry*.
- Change the labeling setting to *New Points Only* (menu *Options* – *Labeling*).







Introduction of a new tool

	Semicircle through 2 Points	New!
	<u>Hint:</u> The order of clicking points <i>A</i> and <i>B</i> determines the direction of the semicircle.	

Hints: Don't forget to read the Toolbar help if you don't know how to use the tool. Try out the new tool before you start the construction.



Construction Steps

1		Draw a segment AB .
2		Construct a semicircle through points A and B .
3		Create a new point C on the semicircle. <u>Hint</u> : Check if point C really lies on the arc by dragging it with the mouse.
4		Create the triangle ABC in counterclockwise direction.
5		Create the interior angles of triangle ABC . <u>Hint</u> : Click in the middle of the polygon.
6		Drag point C to check if your construction is correct.

Challenge: Try to come up with a graphical proof for this theorem.

Hint: Create midpoint O of segment AB and display the radius OC as a segment.

5. Constructing Tangents to a Circle



Back to school...

Open the link to dynamic worksheet called “Constructing Tangents to a Circle“ http://www.geogebra.org/book/intro-en/worksheets/Tangents_Circle.html. Follow the directions on the worksheet in order to find out how to construct tangents to a circle.

Constructing Tangents to a Circle

1. Use the **arrow buttons** in the figure below to review the construction process of tangents to a circle.
2. Try to do this **construction on your own** using the figure to the right.
3. Write down a construction protocol and **explain** every construction step.

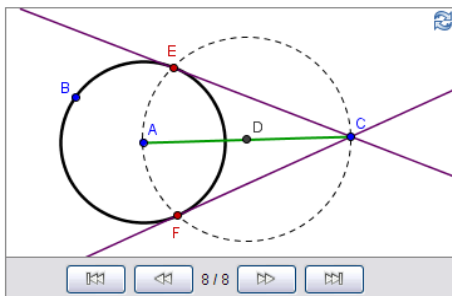

Move: Drag or select objects (Esc)



Discussion

- Which tools did you use in order to recreate the construction?
- Were there any new tools involved in the suggested construction steps? If yes, how did you find out how to operate the new tool?
- Did you notice anything about the Toolbar displayed in the right applet?
- Do you think your students could work with such a dynamic worksheet and find out about construction steps on their own?

What if your mouse and touchpad wouldn't work?

Imagine your mouse and / or touchpad stop working while you are preparing GeoGebra files for tomorrow's lesson. How can you finish the construction file?

GeoGebra offers algebraic input and commands in addition to the geometry tools. Every tool has a matching command and therefore, could be applied without even using the mouse.

Note: GeoGebra offers more commands than geometry tools. Therefore, not every command has a corresponding geometry tool!

Task

Open the  Input Help dialog next to the *Input Bar* to get the list of commands and look for commands whose corresponding tools were already introduced in this workshop.

As you saw in the last activity, the construction of tangents to a circle can be done by using geometric construction tools only. You will now recreate this construction by just using keyboard input.

Preparations

- Open a new GeoGebra window.
- Switch to *Perspectives*  *Algebra & Graphics*.

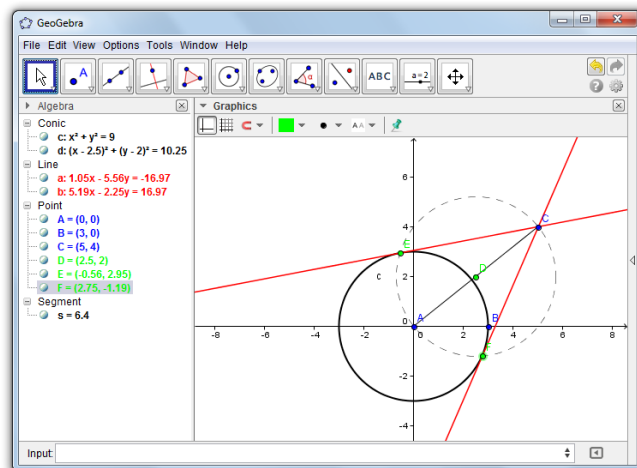



Construction Steps

1	$A = (0, 0)$	Create point A . <u>Hint</u> : The parentheses are closed automatically.
2	$(3, 0)$	Create point B . <u>Hint</u> : If you don't specify a name objects are named in alphabetical order.
3	<code>Circle[A, B]</code>	Construct a circle c with center A through point B . <u>Hint</u> : This circle is a dependent object.

Note: GeoGebra distinguishes between free and dependent objects. While free objects can be directly modified either using the mouse or the keyboard, dependent objects adapt to changes of their parent objects. Thereby, it is irrelevant in which way (mouse or keyboard) an object was initially created!

Task 1

Activate  *Move* mode and double-click an object in the *Algebra View* in order to change its algebraic representation using the keyboard. Hit the *Enter* key once you are done.

Task 2

Use the arrow keys in order to move free objects in a more controlled way. Activate  *Move* mode and select an object (e.g. a free point) in either window. Press the up / down or left / right arrow keys in order to move the object into the desired direction.

4	$C = (5, 4)$	Create point C .
5	<code>s = Segment[A, C]</code>	Create segment AC .
6	<code>D = Midpoint[s]</code>	Create midpoint D of segment AC .
7	<code>d = Circle[D, C]</code>	Construct a circle d with center D through point C .
8	<code>Intersect[c, d]</code>	Create intersection points E and F of the two circles c and d .
9	<code>Line[C, E]</code>	Create a tangent through points C and E .
10	<code>Line[C, F]</code>	Create a tangent through points C and F .



Checking and enhancing the construction

- Perform the drag-test in order to check if the construction is correct.
- Change the properties of the objects in order to improve the construction's appearance (e.g. colors, line thickness, auxiliary objects dashed,...).
- Save the construction.

Discussion

- Did any problems or difficulties occur during the construction steps?
- Which version of the construction (mouse or keyboard) do you prefer and why?
- Why should we use the keyboard for the input if we could also do it using tools?
Hint: There are commands available that have no equivalent geometric tool.
- Does it matter in which way an object was created? Can it be changed in the *Algebra View* (using the keyboard) as well as in the *Graphics View* (using the mouse)?

6. Exploring Parameters of a Quadratic Polynomial



Back to school...

In this activity you will explore the impact of parameters on a quadratic polynomial. You will experience how GeoGebra could be integrated into a 'traditional' teaching environment and used for active and student-centered learning.

Follow the construction steps of this activity and write down your results and observations while working with GeoGebra. Your notes will help you during the following discussion of this activity.

Preparations

- Open a new GeoGebra window.
- Switch to *Perspectives* –  *Algebra & Graphics*.

Construction Steps

1	Type $f(x) = x^2$ into the <i>Input Bar</i> and hit the <i>Enter</i> key. <u>Task:</u> Which shape does the function graph have?
2	 Click on the polynomial in the <i>Algebra View</i> .



3	↑ ↓	Use the ↑ up and ↓ down arrow keys. <u>Task:</u> How does this impact the graph and the equation of the polynomial?
4		Again click on the polynomial in the <i>Algebra View</i> .
5	← →	Use the ← left and → right arrow keys. <u>Task:</u> How does this impact the graph and the equation of the polynomial?
6		Double-click the equation of the polynomial. Use the keyboard to change the equation to $f(x) = 3x^2$. <u>Task:</u> How does the function graph change? Repeat changing the equation by typing in different values for the parameter (e.g. 0.5, -2, -0.8, 3).

Discussion

- Did any problems or difficulties concerning the use of GeoGebra occur?
- How can a setting like this (GeoGebra in combination with instructions on paper) be integrated into a 'traditional' teaching environment?
- Do you think it is possible to give such an activity as a homework problem to your students?
- In which way could the dynamic exploration of parameters of a polynomial possibly affect your students' learning?
- Do you have ideas for other mathematical topics that could be taught in similar learning environment (paper worksheets in combination with computers)?

7. Using Sliders to Modify Parameters



Let's try out a more dynamic way of exploring the impact of a parameter on a polynomial $f(x) = a * x^2$ by using sliders to modify the parameter values.

Preparations

- Open a new GeoGebra window.
- Switch to *Perspectives* – *Algebra & Graphics*.

Construction Steps

1	Create a variable $a = 1$.
---	-----------------------------





2	<p>Display the variable a as a slider in the <i>Graphics View</i>.</p> <p><u>Hint</u>: Click on the symbol \circ next to number a in the <i>Algebra View</i>. Change the slider value by dragging the appearing point on the line with the mouse.</p>
3	<p>Enter the quadratic polynomial $f(x) = a * x^2$.</p> <p><u>Hint</u>: Don't forget to enter an asterisk $*$ or space between a and x^2.</p>
4	<p> Create a slider b using the <i>Slider</i> tool</p> <p><u>Hint</u>: Activate the tool and click on the <i>Graphics View</i>. Use the default settings and click <i>Apply</i>.</p>
5	<p>Enter the polynomial $f(x) = a * x^2 + b$.</p> <p><u>Hint</u>: GeoGebra will overwrite the old function f with the new definition.</p>

Tips and Tricks

- **Name a new object** by typing in `name =` into the *Input Bar* in front of its algebraic representation.
Example: $P = (3, 2)$ creates point P .
- **Multiplication** needs to be entered using an asterisk or space between the factors.
Example: $a*x$ or $a x$
- **GeoGebra is case sensitive!** Thus, upper and lower case letters must not be mixed up.
Note:
 - Points are always named with upper case letters.
Example: $A = (1, 2)$
 - Vectors are named with lower case letters.
Example: $v = (1, 3)$
 - Segments, lines, circles, functions... are always named with lower case letters.
Example: circle $c: (x - 2)^2 + (y - 1)^2 = 16$
 - The variable x within a function and the variables x and y in the equation of a conic section always need to be lower case.
Example: $f(x) = 3*x + 2$
- If you want to use an **object within an algebraic expression** or command you need to create the object prior to using its name in the *Input Bar*.
Examples:
 - $y = m x + b$ creates a line whose parameters are already existing values m and b (e.g. numbers / sliders).
 - $\text{Line}[A, B]$ creates a line through existing points A and B .



- **Confirm an expression** you entered into the *Input Bar* by pressing the *Enter* key.
- **Open the *GeoGebra Help* dialog** for using the *Input Bar* by clicking on the *Input Bar* and pressing *F1*.
- **Error messages:** Always read the messages – they could possibly help to fix the problem!
- **Commands** can be typed in or selected from the list  next to the *Input Bar*.
Hint: If you need further information about a certain command, select  Help from the *Help* menu to open the GeoGebra Manual pages. There you can find detailed descriptions for all commands and tools.
- **Automatic completion of commands:** After typing in the first two letters of a command into the *Input Bar*, GeoGebra tries to complete the command and shows you the required parameters within the brackets.
 - If GeoGebra suggests the desired command, hit the *Enter* key in order to place the cursor within the brackets.
 - If the suggested command is not the one you wanted to enter, just keep typing until the suggestion matches.

8. Challenge of the Day: Parameters of Polynomials

Use the file created in the last activity in order to work on the following tasks:

- Change the parameter value a by moving the point on the slider with the mouse. How does this influence the graph of the polynomial? What happens to the graph when the parameter value is
 - (a) greater than 1,
 - (b) between 0 and 1, or
 - (c) negative?

Write down your observations.

- Change the parameter value b . How does this influence the graph of the polynomial?
- Create a slider for a new parameter c . Enter the quadratic polynomial $f(x) = a * x^2 + b * x + c$. Change the parameter value c and find out how this influences the graph of the polynomial.

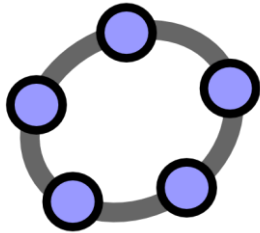







Algebraic Input, Functions & Export of Pictures to the Clipboard

GeoGebra Workshop Handout 3



1. Parameters of a Linear Equation

In this activity you are going to use the following tools, algebraic input and commands. Make sure you know how to use them before you begin with the actual construction.

 Slider $a: y = m x + b$	 Intersect  Slope New!  Move  Delete
 Segment <code>Intersect[a, yAxis]</code>	

Hint: You might want to have a look at the link to the dynamic worksheet "Parameters of a linear equation" <http://www.geogebraTube.org/student/m25968> first.

Preparations

- Open a new GeoGebra window.
- Switch to *Perspectives* -  *Algebra & Graphics*.

Construction Step 1

Enter: $a: y = 0.8 x + 3.2$

Tasks

- Move the line in the *Algebra View* using the arrow keys. Which parameter are you able to change in this way?
- Move the line in the *Graphics View* with the mouse. Which transformation can you apply to the line in this way?



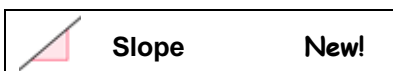





Introduction of new tool



Hints: Don't forget to read the Toolbar help if you don't know how to use the tool. Try out the new tool before you start the construction.



Construction Steps 2

1		Delete the line created in construction step 1.
2		Create sliders m and b using the default settings of sliders.
3		Enter a : $y = m x + b$.
4		Create the intersection point A between the line a and the y -axis. <u>Hint</u> : You can use the command <code>Intersect[a, yAxis]</code> .
5		Create a point B at the origin.
6		Create a segment between the points A and B . <u>Hint</u> : You might want to increase the line thickness make the segment visible on top of the y -axis.
7		Create the slope (triangle) of the line.
8		Hide unnecessary objects. <u>Hint</u> : Instead of using this tool, you can also click on the appropriate symbols  in the <i>Algebra View</i> as well.
9		Enhance the appearance of your construction using the <i>Stylebar</i> .

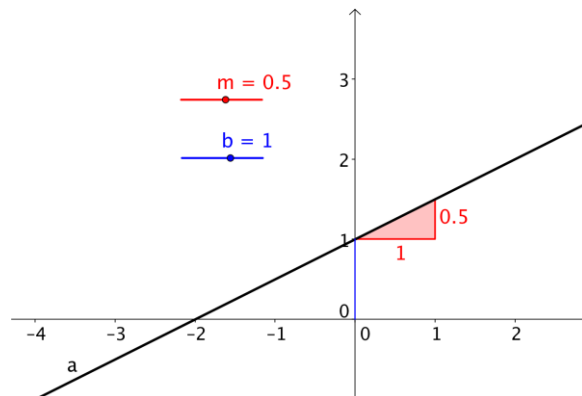

Task

Write down instructions for your students that guide them through examining the influence of the equation's parameters on the line by using the sliders. These instructions could be provided on paper along with the GeoGebra file.



2. Library of Functions – Visualizing Absolute Values



Apart from polynomials there are different types of functions available in GeoGebra (e.g. trigonometric functions, absolute value function, exponential function). Functions are treated as objects and can be used in combination with geometric constructions.

Note: Some of the functions available can be selected from the menu next to the *Input Bar*. Please find a complete list of functions supported by GeoGebra in the GeoGebra Wiki (<http://wiki.geogebra.org/en/>).

Preparations

- Open a new GeoGebra window.
- Switch to *Perspectives* –  *Algebra & Graphics*.

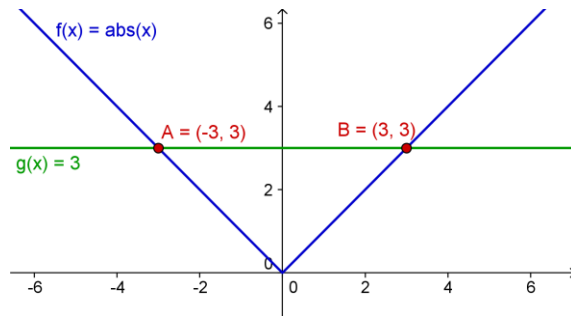

Construction Steps

1	Enter the absolute value function $f(x) = \text{abs}(x)$.
2	Enter the constant function $g(x) = 3$.
3	 Intersect both functions. <u>Hint:</u> You need to intersect the functions twice in order to get both intersection points.

Hint: You might want to close the *Algebra View* and show the names and values as labels of the objects.

Back to school...

(a) Move the constant function with the mouse or using the arrow keys. What is the relation between the y -coordinate and the x -coordinate of each intersection point?

(b) Move the absolute value function up and down either using the mouse or the arrow keys. In which way does the function's equation change?

(c) How could this construction be used in order to familiarize students with the concept of absolute value?

Hint: The symmetry of the function graph indicates that there are usually two solutions for an absolute value problem.



3. Library of Functions – Superposition of Sine Waves



Excursion into physics

Sound waves can be mathematically represented as a combination of sine waves. Every musical tone is composed of several sine waves of form $y(t) = a \sin(\omega t + \varphi)$.



The amplitude a influences the volume of the tone while the angular frequency ω determines the pitch of the tone. The parameter φ is called phase and indicates if the sound wave is shifted in time.

If two sine waves interfere, superposition occurs. This means that the sine waves amplify or diminish each other. We can simulate this phenomenon with GeoGebra in order to examine special cases that also occur in nature.

Preparations

- Open a new GeoGebra window.
- Switch to *Perspectives* –  *Algebra & Graphics*.

Construction Steps

1	 Create three sliders a_1 , ω_1 and φ_1 . <u>Hints:</u> a_1 produces an index. You can select the Greek letters from the menu  next to the text field <i>Name</i> in the <i>Slider</i> dialog window.
2	Enter the sine function $g(x) = a_1 \sin(\omega_1 x + \varphi_1)$. <u>Hint:</u> Again, you can select the Greek letters from a menu next to the text field <i>Name</i> .
3	 Create three sliders a_2 , ω_2 and φ_2 . <u>Hint:</u> Sliders can be moved when the <i>Slider</i> tool is activated.
4	Enter another sine function $h(x) = a_2 \sin(\omega_2 x + \varphi_2)$.
5	Create the sum of both functions $\text{sum}(x) = g(x) + h(x)$.
6	Change the color of the three functions so they are easier to identify.



Back to school...

(a) Examine the impact of the parameters on the graph of the sine functions by changing the values of the sliders.

(b) Set $a_1 = 1$, $\omega_1 = 1$ and $\varphi_1 = 0$. For which values of a_2 , ω_2 and φ_2 does the sum have maximal amplitude?

Note: In this case the resulting tone has the maximal volume.

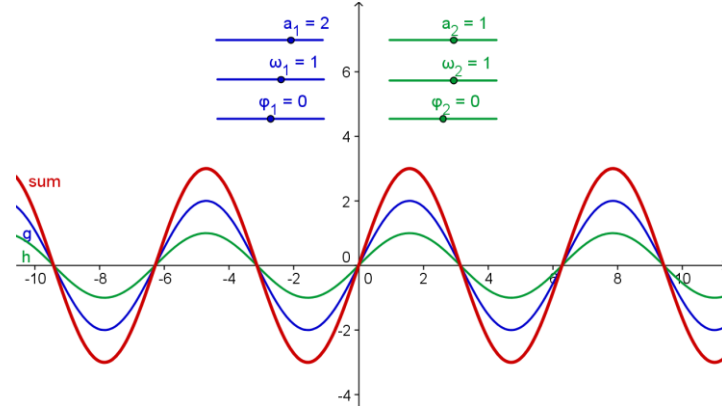

(c) For which values of a_2 , ω_2 , and φ_2 do the two functions cancel each other?
Note: In this case no tone can be heard any more.

4. Introducing Derivatives – The Slope Function



In this activity you are going to use the following tools, algebraic input, and commands. Make sure you know how to use them before you begin with the actual construction.

$$f(x) = x^2/2 + 1$$

 Point

 Tangents

$$m = \text{Slope}[t]$$

$$S = (x(A), m)$$

 Segment

 Move

Hint: You might want to have a look at the link to the dynamic worksheet “Introducing Derivatives – The Slope Function” <http://www.geogebraTube.org/student/m25969> first.

Preparations

- Open a new GeoGebra window.
- Switch to *Perspectives* -  *Algebra & Graphics*.





Introduction of new tool

	Tangents	New!
<u>Hint:</u> Click on a point on a function and then on the function itself.		

Hints: Don't forget to read the Toolbar help if you don't know how to use the tool. Try out the new tool before you start the construction.

Construction Steps

1	Enter the polynomial $f(x) = x^2/2 + 1$.
2	 Create a new point A on function f . <u>Hint:</u> Move point A to check if it is really restricted to the function graph.
3	 Create tangent t to function f through point A .
4	Create the slope of tangent t using: $m = \text{Slope}[t]$.
5	Define point S : $S = (x(A), m)$. <u>Hint:</u> $x(A)$ gives you the x -coordinate of point A .
6	 Connect points A and S using a segment.

Back to school...

- Move point A along the function graph and make a conjecture about the shape of the path of point S , which corresponds to the slope function.
- Turn on the trace of point S . Move point A to check your conjecture.
Hint: Right-click point S (MacOS: *Ctrl-click*) and select  *Trace on*.
- Find the equation of the resulting slope function. Enter the function and move point A . If it is correct the trace of point S will match the graph.
- Change the equation of the initial polynomial f to produce a new problem.

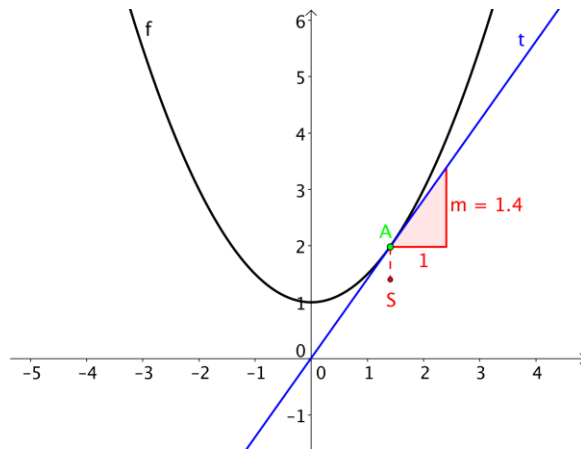



5. Exploring Polynomials



Preparations

- Open a new GeoGebra window.
- Switch to *Perspectives* –  *Algebra & Graphics*.

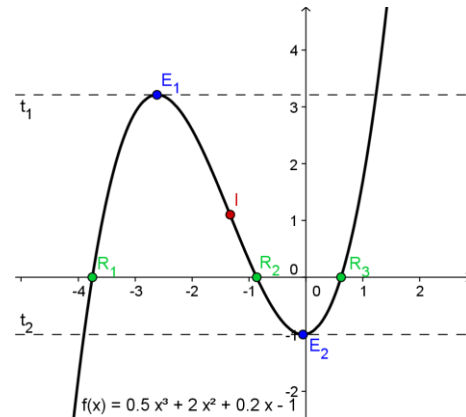

Construction Steps

1	Enter the cubic polynomial $f(x) = 0.5x^3 + 2x^2 + 0.2x - 1$.
2	Create the roots of polynomial f : $R = \text{Root}[f]$ <u>Hint</u> : If there are more than one root GeoGebra will produce indices for their names if you type in $R = (\text{e.g. } R_1, R_2, R_3)$.
3	Create the extrema of polynomial f : $E = \text{Extremum}[f]$. <u>English UK</u> : Create the turning points of polynomial f : $E = \text{TurningPoint}[f]$.
4	 Create tangents to f in E_1 and E_2 .
5	Create the inflection point of polynomial f : $I = \text{InflectionPoint}[f]$.

Hint: You might want to change properties of objects (e.g. color of points, style of the tangents, show name and value of the function).

6. Exporting a Picture to the Clipboard



GeoGebra's *Graphics View* can be exported as a picture to your computer's clipboard. Thus, they can be easily inserted into text processing or presentation documents allowing you to create appealing sketches for tests, quizzes, notes or mathematical games.

GeoGebra will export the whole *Graphics View* into the clipboard. Thus, you need to make the GeoGebra window smaller in order to reduce unnecessary space on the drawing pad:

- Move your figure (or the relevant section) to the upper left corner of the *Graphics View* using the  *Move Graphics View* tool (see left figure below).



- Hint: You might want to use tools *Zoom in* and *Zoom out* in order to prepare your figure for the export process.
- Reduce the size of the GeoGebra window by dragging its lower right corner with the mouse (see right figure below).
Hint: The pointer will change its shape when hovering above an edges or corner of the GeoGebra window.

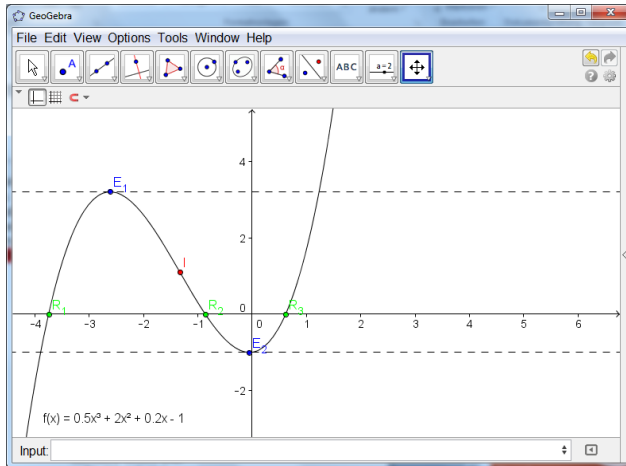

GeoGebra window before
the size reduction

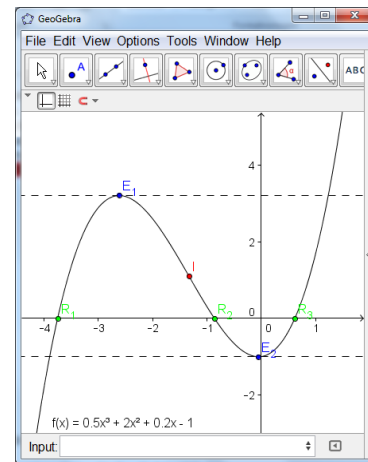

GeoGebra window after
the size reduction

Use the *File* menu to export the *Graphics View* to the clipboard:

- Export – Graphics View to Clipboard*
Hint: You could also use the key combination *Ctrl – Shift – C* (MacOS: *Cmd – Shift – C*).
- Your figure is now stored in your computer's clipboard and can be inserted into any word processing or presentation document.

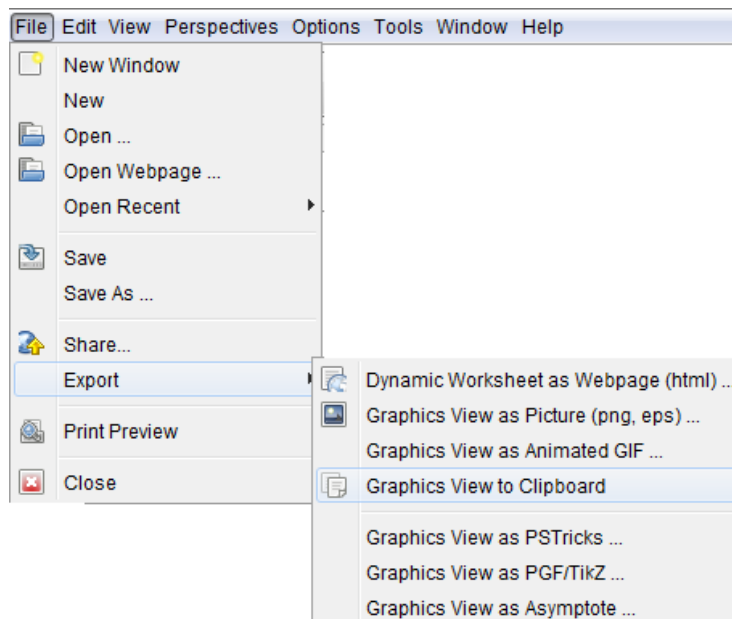



7. Inserting Pictures into a Text Processing Document

Inserting pictures from the clipboard to MS Word



After exporting a figure from GeoGebra into your computer's clipboard you can now paste it into a word processing document (e.g. MS Word).

- Open a new text processing document.
- From the *Home* menu select *Paste*. The picture is inserted at the position of the cursor.

Hint: You can use the key combination *Ctrl – V* (MacOS: *Cmd – V*) instead.

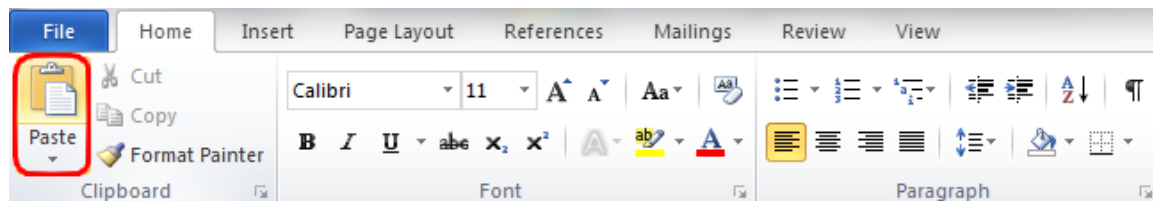

Reducing the size of pictures

If necessary you can reduce the size of the picture in MS Word:

- Double-click the inserted picture.
- Change the height/width of the picture using the *Size* group on the right.

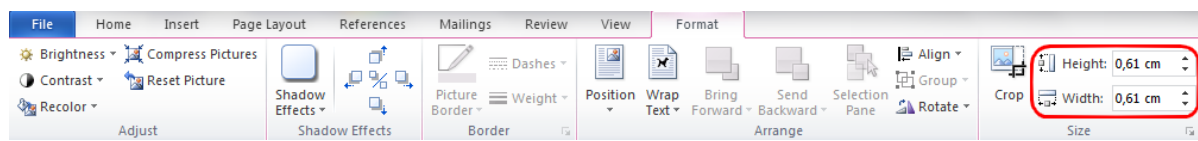

Note: If you change the size of a picture, the scale is modified. If you want to maintain the scale (e.g. for your students to measure lengths) make sure the size of the picture is 100%.

Note: If a picture is too big to fit on one page MS Word will reduce its size automatically and thus, change its scale.

Inserting pictures from the clipboard to OO Writer

- Open a new text processing document
- From the *Edit* menu select *Paste* or use the key combination *Ctrl – V* (MacOS: *Cmd – V*).

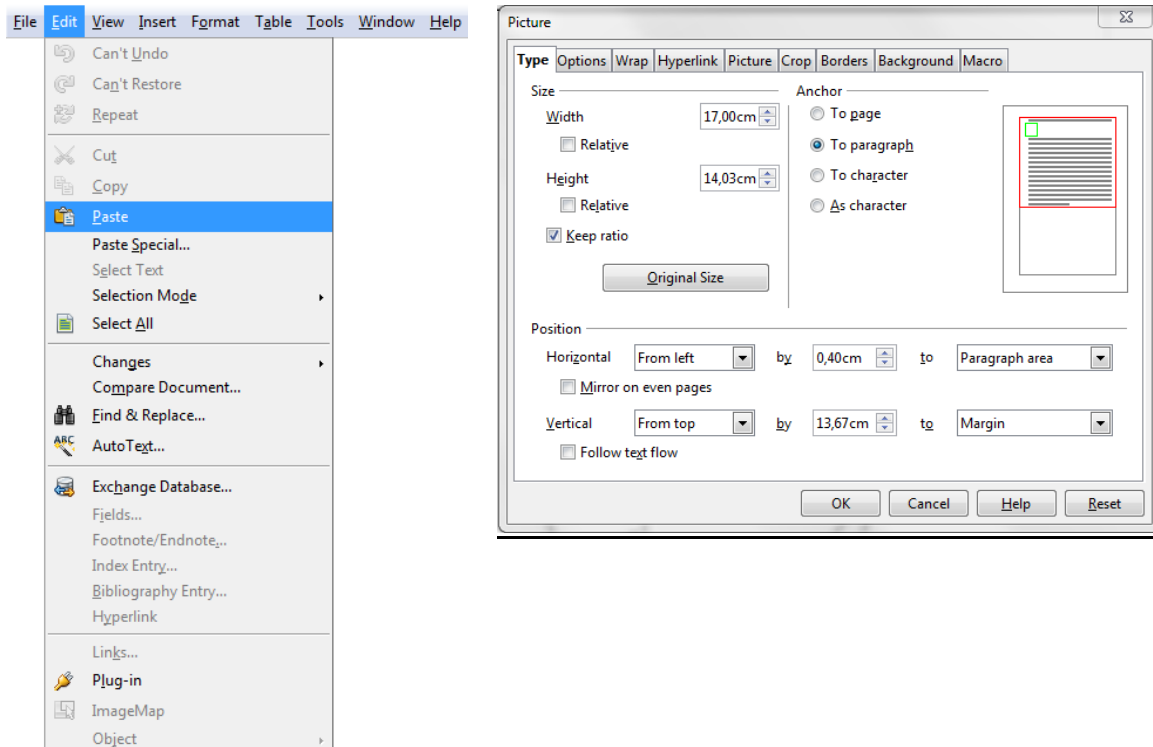

Reducing the size of pictures in OO Writer

- Double-click the inserted picture.
- Select the *Type* tab in the appearing *Picture* window.
- Change width/height of the picture.
- Click *OK*.

8. Challenge of the Day: Creating Instructional Materials

Pick a mathematical topic of your interest and create a worksheet / notes / quiz for your students.

- Create a figure in GeoGebra and export it to the clipboard.
- Insert the picture into a word processing document.
- Add explanations / tasks / problems for your students.

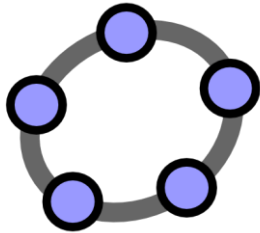

Transformations & Inserting Pictures into the Graphics View

GeoGebra Workshop Handout 4



1. Creating a 'Function Domino' Game

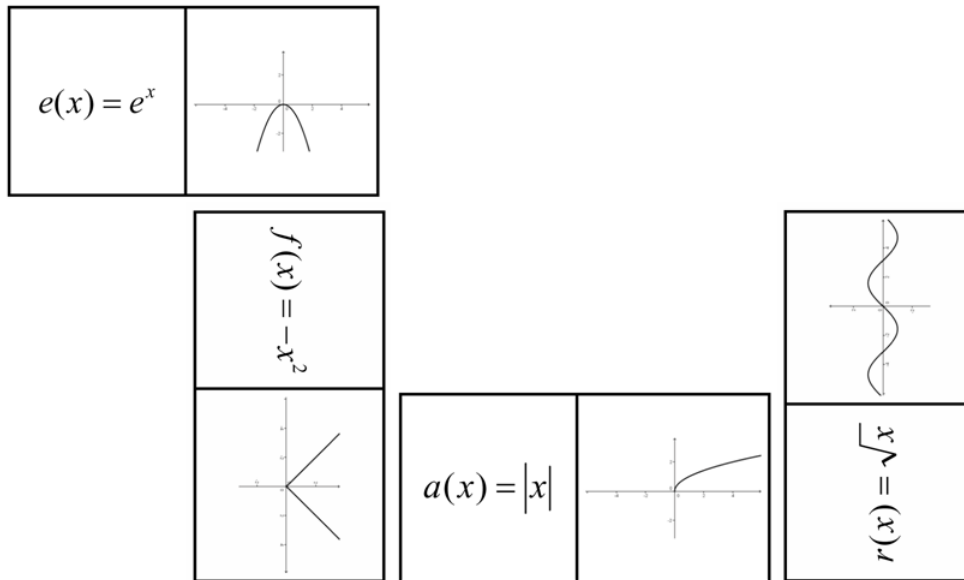

In this activity you are going to practice exporting function graphs to the clipboard and inserting them into a word processing document in order to create cards for a 'Function Domino' game. Make sure you know how to enter different types of functions before you begin with this activity.



Preparations

- Open a new GeoGebra window.
- Switch to *Perspectives* –  *Algebra & Graphics*.

Construction Steps for GeoGebra

1	Enter an arbitrary function. <u>Examples:</u> $e(x) = \exp(x)$ or $f(x) = \sin(x)$
2	 Move the function graph into the upper left corner of the <i>Graphics View</i> .
3	Reduce the size of the GeoGebra window so it only shows the desired part of the <i>Graphics View</i> .
4	Export the <i>Graphics View</i> to the clipboard. <u>Hint:</u> Menu <i>File – Export</i> –  <i>Graphics View to Clipboard</i> .



Construction Steps for MS Word

1	Open a new word processing document (e.g. MS Word).
2	Create a table with 2 columns and several rows. <u>Hint</u> : Menu <i>Insert – Table...</i>
3	Highlight the entire table (all cells) and open the <i>Table Properties dialog</i> . <u>Hint</u> : right-click – <i>Table Properties...</i>
4	Click on tab <i>Row</i> and specify the row height as 2 inches.
5	Click on tab <i>Column</i> and set the preferred width of the columns to 2 inches.
6	Click on tab <i>Cell</i> and set the vertical alignment to <i>Center</i> .
7	Click the <i>OK</i> button.
8	Place the cursor in one of the table cells. Insert the function graph picture from the clipboard. <u>Hint</u> : Menu <i>Home – Paste</i> or key combination <i>Ctrl – V</i> (MacOS: <i>Cmd – V</i>).
9	Adjust the size of the picture if necessary. <u>Hint</u> : Double-click the picture to open the <i>Format</i> tab and click on <i>Size</i> and set the longer side (either width or height) to 1.9 inches.
10	Enter the equation of a different function into the cell next to the picture. <u>Hint</u> : You might want to use an equation editor.

Repeat the steps in GeoGebra for a different function (e.g. trigonometric, logarithmic) and insert the new picture into MS Word in order to create another domino card.

Hint: Make sure to put the equation and graph of each function on different domino cards.

2. Creating a ‘Geometric Figures Memory’ Game



In this activity you are going to practice exporting geometric figures to the clipboard and inserting them into a word processing document in order to create cards for a memory game with geometric figures. Make sure you know how to construct different geometric figures (e.g. quadrilaterals, triangles) before you begin with this activity.

Preparations

- Open a new GeoGebra window.
- Switch to *Perspectives –  Geometry*.



Construction Steps for GeoGebra

1	Construct a geometric figure (e.g. isosceles triangle).
2	Use the <i>Stylebar</i> to enhance your construction.
3	Move the figure into the upper left corner of the <i>Graphics View</i> and adjust the size of the GeoGebra window.
4	Export the <i>Graphics View</i> to the clipboard. <u>Hint:</u> Menu <i>File – Export –  Graphics View to Clipboard.</i>

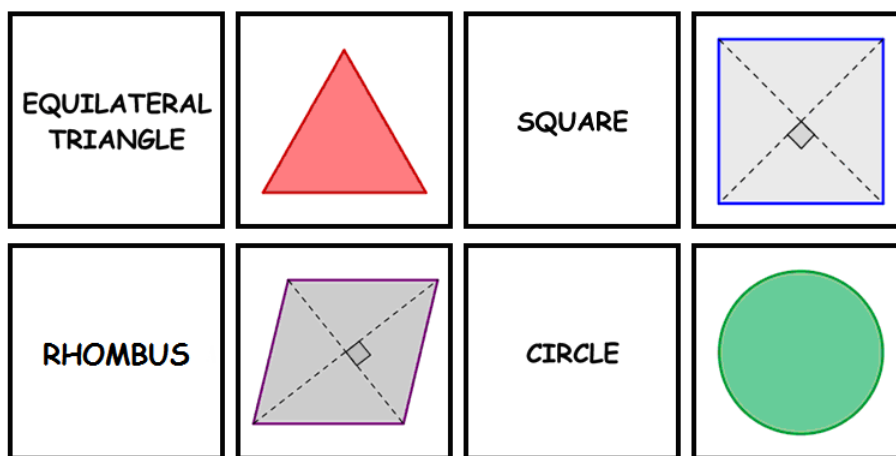

Construction Steps for MS Word

1	Open a new word processing document (e.g. MS Word).
2	Create a table with 2 columns and several rows. <u>Hint:</u> Menu <i>Insert – Table...</i>
3	Highlight the entire table (all cells) and open the <i>Table Properties dialog</i> . <u>Hint:</u> right-click – <i>Table Properties...</i>
4	Click on tab <i>Row</i> and specify the row height as 2 inches.
5	Click on tab <i>Column</i> and set the preferred width of the columns to 2 inches.
6	Click on tab <i>Cell</i> and set the vertical alignment to <i>Center</i> .
7	Click the <i>OK</i> button.
8	Place the cursor in one of the table cells. Insert the picture of the geometric figure from the clipboard. <u>Hint:</u> Menu <i>File – Paste</i> or key combination <i>Ctrl – V</i> (MacOS: <i>Cmd – V</i>).



- Adjust the size of the picture if necessary.
- 9 Hint: Double-click the picture to open the *Format* tab. Then click on *Size* and set the longer side of the picture to 1.9 inches.
- 10 Enter the name of the geometric shape into another cell of the table.

Repeat the steps in GeoGebra for a different geometric shape (e.g. parallelogram, circle, triangle) and insert the new picture into MS Word in order to create another memory card.

Hint: Make sure to put the name and sketch of each geometric shape on one of the memory cards.



3. Exploring Symmetry with GeoGebra

Back to school...

Open the link to the dynamic worksheet “Axes of Symmetry” <http://www.geogebraTube.org/student/m27273>. Follow the directions on the worksheet and experience how your students could explore the axes of symmetry of a flower.

Hint: You will learn how to create such dynamic worksheets later in this workshop.

Axes of Symmetry

Below you can see a point **A** who was reflected at the line in order to create its image **A'**.

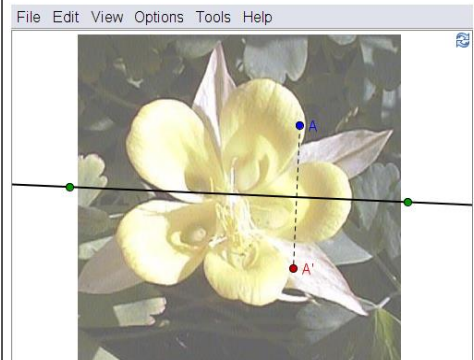

1. **Drag point A** with the mouse along the outline of the flower. What do you notice? Write down your **observations**.
2. How many **axes of symmetry** does this flower have?
Hint: Drag the **green points** in order to **change the position of the line** of reflection. Then, repeat step (1) for every position of the line.
Hint: Press the keys **Ctrl + F** at the same time in order to **delete the traces**.
3. Make a **sketch** of this worksheet including the flower and all lines of symmetry you were able to find.

Discussion



- How could your students benefit from this prepared construction?
- Which tools were used in order to create the dynamic figure?



Preparations









- Make sure you have the picture <http://www.geogebra.org/book/intro-en/worksheets/flower.jpg> saved on your computer.
- Open a new GeoGebra window.
- Switch to *Perspectives* –  *Geometry*.

Introduction of new tools

	Show / Hide Label	New!
	Reflect about Line <u>Hint:</u> Click the object to be mirrored and then click the line of reflection.	New!

Hints: Don't forget to read the Toolbar help if you don't know how to use these tools. Try out the new tools before you start the construction.

Construction Steps

1		Create a new point <i>A</i> .
2		Show the label of point <i>A</i> . <u>Hint:</u> The label style can be set in the <i>Stylebar</i> as well.
3		Construct a line of reflection through two points.
4		Create mirror point <i>A</i> at line to get image <i>A'</i> .
5		Create a segment between point <i>A</i> and its image <i>A'</i> .
6		Turn the <i>Trace on</i> for points <i>A</i> and <i>A'</i> . <u>Hint:</u> Right-click (MacOS: <i>Ctrl</i> -click) the point and select <i>Trace on</i> . Whenever point <i>A</i> is moved it leaves a trace in the <i>Graphics View</i> .
7		Move point <i>A</i> to draw a dynamic figure.
8		Insert the image you saved into the <i>Graphics View</i> . <u>Hint:</u> Click in the lower left corner of the <i>Graphics View</i> to insert the picture at this position.
9		Adjust the position of the inserted image.
10		Set the image as <i>Background Image</i> (<i>Properties dialog</i> , tab <i>Basic</i>).
11		Reduce the <i>Opacity</i> of the image (<i>Properties dialog</i> , tab <i>Color</i>). <u>Hint:</u> After specifying the picture as a background image you can't select it in the <i>Graphics View</i> any more.



Hint: The  *Trace on* feature has some special characteristics:

- The trace is a temporary phenomenon. Whenever the graphics are refreshed, the trace disappears.
- The trace can't be saved and isn't shown in the *Algebra View*.
- To delete the trace you need to refresh the views (menu *View – Refresh Views* or key combination *Ctrl – F*. MacOS: *Cmd – F*).

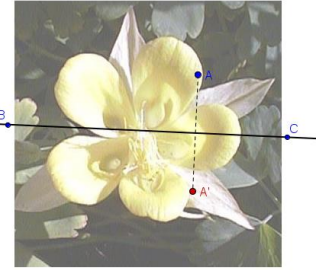

4. Resizing, Reflecting and Distorting a Picture

In this activity you will learn how to resize an inserted picture to a certain size and how to apply transformations to the picture in GeoGebra.





Preparations

- Make sure you have the picture from http://www.geogebra.org/book/intro-en/worksheets/Sunset_Palmtrees.jpg saved on your computer.
- Open a new GeoGebra window.
- Switch to *Perspectives – Geometry* and show the *Input Bar* (*View* menu – *Input Bar*).



Construction Steps for reflecting and resizing a picture



1		Insert picture you saved on the left part of the <i>Graphics View</i> .
2		Create a new point <i>A</i> at the lower left corner of the picture.
3		Set the point <i>A</i> as the FIRST corner point of your picture. <u>Hint:</u> Open the <i>Properties dialog</i> and select the picture in the list of objects. Click on tab <i>Position</i> and select point <i>A</i> from the drop-down list next to <i>Corner 1</i> .
4		Create a new point $B = A + (3, 0)$.
5		Set the point <i>B</i> as the SECOND corner point of the picture. <u>Hint:</u> You just changed the width of the picture to 3 cm.
6		Create a line through two points in the middle of the <i>Graphics View</i> .
7		Mirror the picture at the line. <u>Hint:</u> You might want to reduce the opacity of the image in order to be able to better distinguish it from the original (<i>Properties dialog</i>).





Back to school...

- Move point A with the mouse. How does this affect the picture?
- Move the picture with the mouse and observe how this affects its image.
- Move the line of reflection by dragging the two points with the mouse. How does this affect the image?



Construction Steps for distorting a picture

1		Open the figure you created in the previous activity.
2		Delete the point B to restore the picture's original size.
3		Create a new point B at the lower right corner of the original picture.
4		Set the new point B as the SECOND corner point of your picture. <u>Hint</u> : You can now resize the image by moving point B .
5		Create a new point E at the upper left corner of the original picture. <u>Hint</u> : Type any letter to open the <i>Rename</i> dialog window.
6		Set the new point E as the FOURTH corner point of your picture.

Back to school...

- How does moving point E affect the picture and its image?
- Which geometric shape do the picture and the image form at any time?

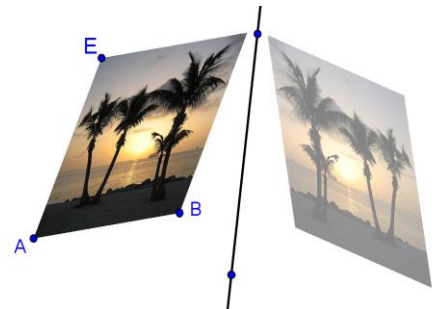



5. Exploring Properties of Reflection

In this activity you will create a dynamic figure that allows your students to explore the properties of reflection.

Preparations

You will now modify the construction created in the previous activity. If you want to keep the original as well you need to save your file.

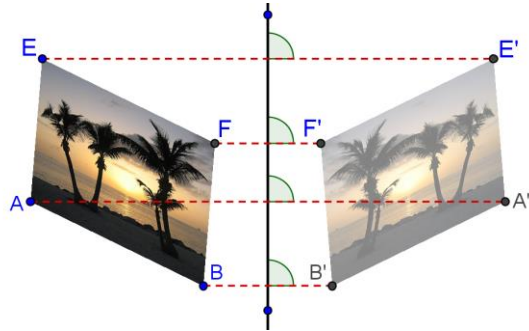

Construction Steps

1		Open the file you created in the previous activity which contains the distorted picture of the palm trees and its reflection at a line.
2		Create a segment between points A and B .
3		Create a segment between points A and E .
4		Create a parallel line to segment AB through point E .
5		Create a parallel line to segment AE through point B .
6		Intersect the two lines to get intersection point F .
7		Hide auxiliary objects by unchecking the checkboxes.
8		Reflect all four corner points A , B , E and F at the line to get their images A' , B' , E' and F' .
9		Connect corresponding points with segments (e.g. points A and A').
10		Create angles between the line of reflection and the segments.

Back to school...

(a) Move the corner points A , B , E and F of the original picture. Are you able to drag all these points with the mouse? If no, which one can't be dragged and why?



(b) Move the line of reflection. What do you notice about the angles between the segments connecting the corresponding corner points and the line of reflection?



(c) What can we call the line of reflection in relation to the segments formed by each point and its corresponding image?





6. Translating Pictures

In this activity you are going to use the following tools and commands. Make sure you know how to use each tool and command before you begin.

	Image $A = (1, 1)$	
	Rigid Polygon	New!
	$\text{Vector}[O, P]$	



	Vector	New!
	Translate by Vector	New!
	Move	
ABC	Text	

Preparations

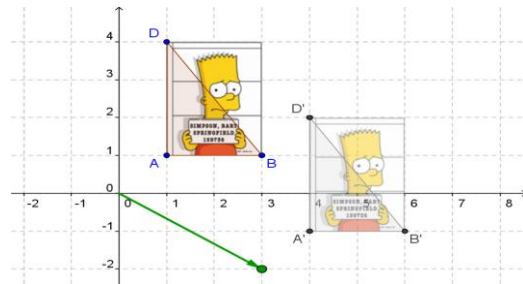
- Make sure you have the picture from <http://www.geogebra.org/book/intro-en/worksheets/Bart.png> saved on your computer.
- Open a new GeoGebra window.
- Switch to *Perspectives* –  *Algebra* & *Graphics* and show the  *Grid (Stylebar)*.
- Set the  *Point Capturing* to *Fixed to Grid (Stylebar)*.



Introduction of new tools

	Vector	New!
	Hint: First click determines the starting point and second click sets the vector's endpoint.	
	Translate by Vector	New!
	Hint: Click the object to be translated and then click the translation vector.	
	Rigid Polygon	New!
	Hint: Select all vertices, then click first vertex again. The resulting polygon will keep its shape when moved. It can be moved or rotated by dragging two vertices.	

Hints: Don't forget to read the Toolbar help if you don't know how to use these tools. Try out the new tools before you start the construction.

Construction Steps

1		Insert picture http://www.geogebra.org/book/intro-en/worksheets/Bart.png into the first quadrant.
2		Create points $A = (1, 1)$, $B = (3, 1)$ and $D = (1, 4)$.



3		Set point A as the FIRST, B as the SECOND and D as the FOURTH corner point of the picture. (<i>Properties dialog - Position</i>)
4		Create triangle ABD .
5		Create points $O = (0, 0)$ and $P = (3, -2)$.
6		Create vector $u = \text{Vector}[O, P]$. <u>Hint</u> : You could also use tool <i>Vector</i> .
7		Translate the picture by vector u . <u>Hint</u> : You might want to reduce the opacity of the image.
8		Translate the three corner points A , B and D by vector u .
9		Create triangle $A'B'D'$.
10		Hide point O so it can't be moved accidentally.
11		Change the color and size of objects to enhance your construction.

7. Rotating Polygons



In this activity you are going to use the following tools and commands. Make sure you know how to use each tool and command before you begin.

	Polygon		Rotate around Point	New!
	Point		Segment	
	Rename		Angle	
	Slider		Move	

Preparations

- Open a new GeoGebra window.
- Switch to *Perspectives* – *Geometry* and show the coordinate axes.
- Click on *Preferences* in the *Toolbar* and choose *Graphics* to open the *Properties dialog* for the *Graphics View*.
 - On tab *xAxis* change the *Distance* to 1.
 - On tab *yAxis* change the *Distance* to 1.











Introduction of new tool

	Rotate around Point	New!
<p><u>Hint:</u> Click the object to be rotated, the center of rotation and enter the angle in the appearing dialog window.</p>		

Hints: Don't forget to read the Toolbar help if you don't know how to use the tool. Try out the new tool before you start the construction.

Construction Steps

1		Create an arbitrary triangle ABC in the second quadrant placing the vertices on grid points.
2		Create a new point D at the origin of the coordinate system.
3		Rename the point D to O . <u>Hint:</u> Just type "O" to open the <i>Rename</i> dialog.
4		Create a slider for angle α . <u>Hint:</u> In the <i>Slider</i> dialog window check <i>Angle</i> and set the <i>Increment</i> to 90° . Make sure you don't delete the $^\circ$ symbol.
5		Rotate triangle ABC around point O by angle α . <u>Hint:</u> Check <i>counter clockwise</i> rotation.
6		Create segments AO and $A'O$.
7		Create angle AOA' . <u>Hint:</u> Select the points in counter clockwise order. Hide the label of this angle.
8		Move slider and check the image of the triangle.

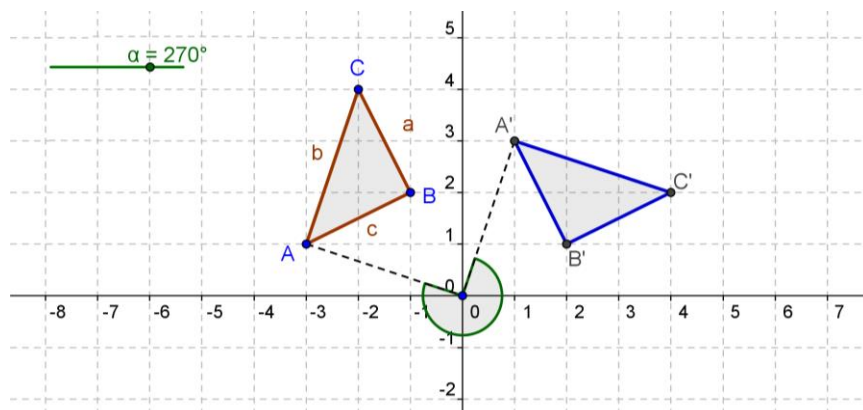





Enhancing the construction

You will now learn how to ‘tidy up’ the *Algebra View* by defining some objects as *Auxiliary objects* and hiding their algebraic representation from view.

- Show the *Algebra View*

Hint: menu *View* –  *Algebra*.

- Open the  *Properties dialog* for  *Objects*.
- Select all segments in the *Properties dialog* and check *Auxiliary object* on tab *Basic*.

Hint: Click on the heading *Segment* in order to select all segments.

- Repeat this step for the triangles, angles and point *O* at the origin.
- Hint: The *Algebra View* now only contains points *A*, *B* and *C* as well as their images *A'*, *B'* and *C'*.
- You can now show or hide the *Auxiliary Objects* by toggling the *Auxiliary Objects* button in *Algebra Views Stylebar*.

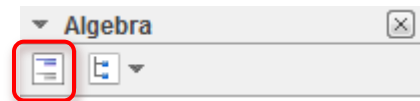

Note: Your students can now check out the coordinates of the initial points and their images in the algebra window without being distracted by the algebraic representation of the other objects used in this construction.

8. Challenge of the Day: Tiling with Regular Polygons

Open the collection “Tilings” with a series of ten dynamic worksheets: <http://www.geogebraTube.org/student/c2660/m27274/ylyy>. The first one of a series of ten dynamic worksheets that forms a learning environment to explore tiling with regular polygons opens.

Hint: Use either the navigation left to the worksheet or the “Previous/Next in Collection”-button beneath the worksheet to navigate in this learning environment.

Back to school...

- (a) Work through the tasks on the dynamic worksheets of this learning environment. Write down your answers on paper and discuss them with colleagues afterwards.
- (b) After working through the dynamic worksheets you should be able to answer the following questions:
 - Which regular polygons can be used to tile the plane?
 - Which transformation(s) did you use for the tiling?
 - How many of each of these polygons meet at one of their edges?



- (c) Fill in the missing values in the table below. Can you see any patterns? Try to find the formulas for an n -sided polygon.

# vertices	polygon		parts		polygon interior angles
	tiling possible yes / no	# meet	central angle	interior angles	
3			---	---	
4					
5					
6					
7					
...
n					

- (d) Come up with a conjecture that helps you to reason why not every regular polygon can be used for tiling.



Tiling with regular polygons – worksheet solution

polygon			parts		polygon
# of vertices	tiling possible yes / no	# for tiling	central angle	interior angles	interior angles
3	yes	6	---	---	60°
4	yes	4	$\frac{360^\circ}{4} = 90^\circ$	$\frac{180^\circ - 90^\circ}{2} = 45^\circ$	$2 \times 45^\circ = 90^\circ$
5	no	---	$\frac{360^\circ}{5} = 72^\circ$	$\frac{180^\circ - 72^\circ}{2} = 54^\circ$	$2 \times 54^\circ = 108^\circ$
6	yes	3	$\frac{360^\circ}{6} = 60^\circ$	$\frac{180^\circ - 60^\circ}{2} = 60^\circ$	$2 \times 60^\circ = 120^\circ$
7	no	---	$\frac{360^\circ}{7} \gg 51\frac{3}{7}$	$\frac{180^\circ - 51\frac{3}{7}}{2} \gg 64\frac{2}{7}$	$2 \times 64\frac{2}{7} = 128\frac{4}{7}$
...
n	no for $n > 6$	---	$\frac{360^\circ}{n}$	$\frac{180^\circ - \frac{360^\circ}{n}}{2}$	$180^\circ - \frac{360^\circ}{n}$

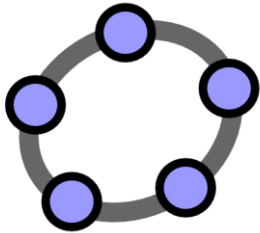



Inserting Static and Dynamic Text into the GeoGebra's Graphics View

GeoGebra Workshop Handout 5





1. Coordinates of Reflected Points

Preparations

- Open a new GeoGebra window.
- Switch to *Perspectives* –  *Algebra & Graphics* and show the  *Grid*.
- In the *Stylebar* set the  *Point capturing* to *Fixed to Grid*.

Construction Steps

1		Create point $A = (3, 1)$.
2		Create line $a: y = 0$.
3		Mirror point A at line a to get point A' . <u>Hint</u> : You might want to match the color of line a and point A' .
4		Create line $b: x = 0$.
5		Mirror point A at line b to get point A_1' . <u>Hint</u> : You might want to match the color of line b and point A_1' .



2. Inserting Text into the Graphics View

Introduction of new tool

	Text	New!
ABC	<u>Hint</u> : Click on the <i>Graphics View</i> to specify the location of your text. Enter the desired text into the appearing window and click <i>OK</i> .	

Hints: Don't forget to read the *Toolbar help* if you don't know how to use a tool. Try out the new tool before you start the construction.

Inserting static text

Insert a heading into the *Graphics View* of GeoGebra so your students know what this dynamic figure is about:

- Activate the  *Text* tool and click on the upper part of the *Graphics View*.



- Type the following text into the appearing window:
Reflecting a point at the coordinate axes
- Change the properties of the text using the *Stylebar* (e.g. wording, font style, font size, formatting).
- Adjust the position of the text using the *Move* tool.
- Fix the position of the text so it can't be moved accidentally (*Properties dialog* – tab *Basic* – *Fix object*).

Inserting dynamic text

Dynamic text refers to existing objects and adapts automatically to modifications, for example in $A = (3, 1)$ the coordinates change whenever point A is moved.

- Activate the ^{ABC} *Text* tool and click on the *Graphics View*.
- Type $A =$ into the appearing window.
Hint: This will be the static part of the text and won't change if point A is moved.
- Insert the dynamic part of this text by selecting point A from the *Objects* drop-down list.
- Click *OK*.

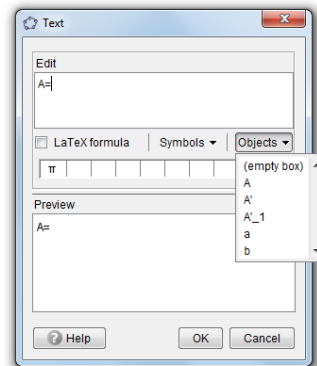

Enhancing the dynamic figure

- Insert dynamic text that shows the coordinates of the reflected points A' and A_1' .
- Zoom out in order to show a larger part of the coordinate plane.
Hint: You might want to adjust the distance of the grid lines.
 - Open the *GeoGebra Properties dialog* for the *Graphics View*.
 - Select tab *Grid*.
 - Check the box next to *Distance* and change the values in both text fields to 1.
- Close the *Algebra View* and fix all text so it can't be moved accidentally.

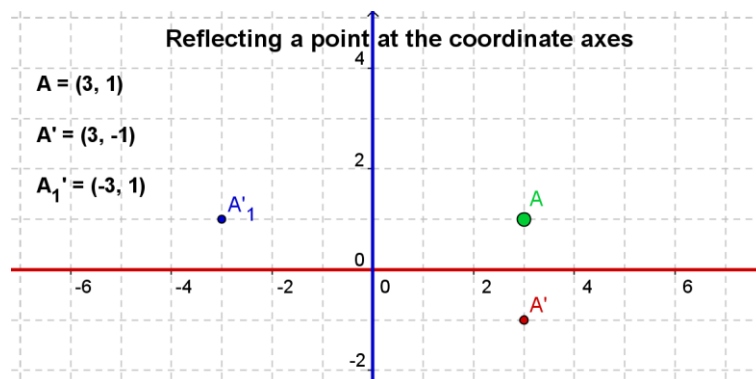





Task

Come up with instructions to guide your students towards discovering the relation between the coordinates of the original and the reflected points which could be provided along with the dynamic figure.

3. Visualizing a System of Linear Equations





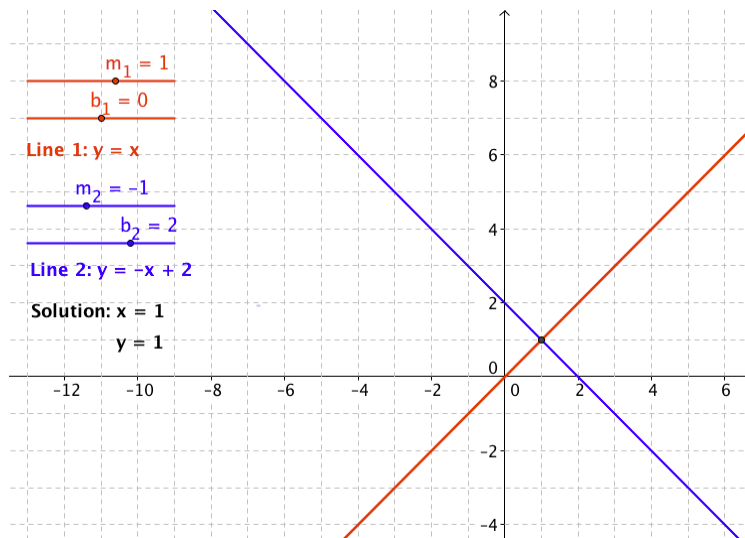

Preparations

- Open a new GeoGebra window.
- Switch to *Perspectives* –  *Algebra & Graphics* and show the  *Grid*.



Construction Steps

1	 Create slider m_1 with the default settings for sliders. <u>Hint:</u> m_1 gives you m_1 .
2	 Create slider b_1 with the default settings for sliders.
3	Create the linear equation $line_1: y = m_1 x + b_1$.
4	 Create slider m_2 using the default settings for sliders.
5	 Create slider b_2 using the default settings for sliders.
6	Create linear equation $line_2: y = m_2 x + b_2$.



7	ABC	Create the dynamic <i>text1</i> : Line 1: and select <i>line_1</i> from <i>Objects</i> .
8	ABC	Create the dynamic <i>text2</i> : Line 2: and select <i>line_2</i> from <i>Objects</i> .
9		Construct the intersection point <i>A</i> of both lines <i>line₁</i> and <i>line₂</i> . <u>Hint</u> : You could use command <code>Intersect[line_1, line_2]</code> instead.
10		Define <code>xcoordinate = x(A)</code> . <u>Hint</u> : <code>x(A)</code> gives you the <i>x-coordinate</i> of point <i>A</i> .
11		Define <code>ycoordinate = y(A)</code> . <u>Hint</u> : <code>y(A)</code> gives you the <i>y-coordinate</i> of point <i>A</i> .
12	ABC	Create the dynamic <i>text3</i> : Solution: $x =$ and select <i>xcoordinate</i> from <i>Objects</i> .
13	ABC	Create the dynamic <i>text4</i> : $y =$ and select <i>ycoordinate</i> from <i>Objects</i> .
14		Fix the text and sliders so they can't be moved accidentally.

Challenge

Create a similar construction that allows for visualizing the graphical solution of a system of quadratic polynomials.





Hint: Functions need to be entered using the syntax $f(x) = \dots$



Note: Such a dynamic figure can also be used to visualize an equation in one variable by entering each side of the equation as one of the two functions.

4. Visualizing the Angle Sum in a Triangle



In this activity you are going to use the following tools. Make sure you know how to use each tool before you begin.

	Polygon
	Angle
	Slider
	Midpoint

	Rotate around Point
	Move
ABC	Text



Preparations

- Open a new GeoGebra window.
- Switch to *Perspectives* –  *Geometry*.
- Show the *Input Bar* (*View* menu).
- Set the number of decimal places to 0 (menu *Options* – *Rounding*).

$$\begin{array}{l} \delta = 180^\circ \\ \epsilon = 180^\circ \end{array} \quad \begin{array}{l} \alpha = 58^\circ \\ \beta = 50^\circ \\ \gamma = 72^\circ \end{array} \quad \alpha + \beta + \gamma = 180^\circ$$

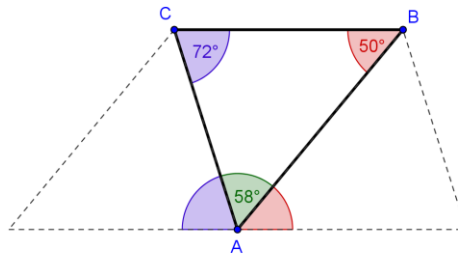









Introduction of new tool

	Midpoint or Center	New!
Hint: Select two points, one segment, circle or conic to get the midpoint or center.		

Hints: Don't forget to read the Toolbar help if you don't know how to use a tool. Try out the new tool before you start the construction.

Construction Steps

1		Create a triangle ABC with counter clockwise orientation.
2		Create the angles α , β and γ of triangle ABC .
3		Create a slider for angle δ with <i>Interval</i> 0° to 180° and <i>Increment</i> 10° .
4		Create a slider for angle ϵ with <i>Interval</i> 0° to 180° and <i>Increment</i> 10° .
5		Create midpoint D of segment AC and midpoint E of segment AB .
6		Rotate the triangle around point D by angle δ (setting <i>clockwise</i>).
7		Rotate the triangle around point E by angle ϵ (setting <i>counterclockwise</i>).
8		Move both sliders δ and ϵ to show 180° .
9		Create angle ζ using the points $A'C'B'$.









10		Create angle η using the points $C'_1B'_1A'_1$.
11		Enhance your construction using the <i>Stylebar</i> . <u>Hint</u> : Congruent angles should have the same color.
12	ABC	Create dynamic text displaying the interior angles and their values (e.g. $\alpha =$ and select α from <i>Objects</i>).
13		Calculate the angle sum using $\text{sum} = \alpha + \beta + \gamma$
14	ABC	Insert the angle sum as a dynamic text: $\alpha + \beta + \gamma =$ and select sum from <i>Objects</i> .
15		Match colors of corresponding angles and text. Fix the text that is not supposed to be moved.



5. Constructing a Slope Triangle



In this activity you are going to use the following tools and algebraic input. Make sure you know how to use each tool and the syntax for algebraic input before you begin.

 Line  Perpendicular Line  Intersect  Polygon $\text{rise} = y(B) - y(A)$	$\text{run} = x(B) - x(A)$ $\text{slope} = \text{rise} / \text{run}$ ABC Text  Midpoint or Center  Move
--	---

Preparations

- Open a new GeoGebra window.
- Switch to *Perspectives* –  *Algebra & Graphics* and show the  *Grid*.
- Set the  *Point Capturing* to *Fixed to Grid*.
- Set the labeling to *All New Objects* (menu *Options* – *Labeling*).

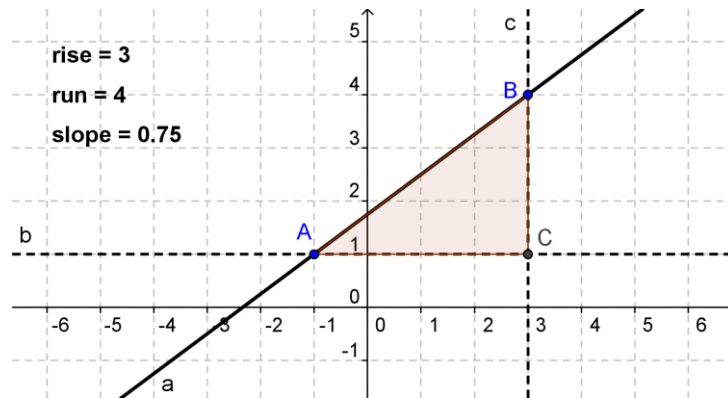

Construction Steps

1		Create a line <i>a</i> through two points <i>A</i> and <i>B</i> .
2		Construct a perpendicular line <i>b</i> to the <i>y</i> -axis through point <i>A</i> .
3		Construct a perpendicular line <i>c</i> to the <i>x</i> -axis through point <i>B</i> .
4		Intersect perpendicular lines <i>b</i> and <i>c</i> to get intersection point <i>C</i> . <u>Hint</u> : You might want to hide the perpendicular lines.
5		Create a triangle <i>ACB</i> .
6	AA	Hide the labels of the triangle sides using the <i>Stylebar</i> .
7		Calculate the rise: $\text{rise} = y(B) - y(A)$. <u>Hint</u> : $y(A)$ gives you the <i>y</i> -coordinate of point <i>A</i> .
8		Calculate the run: $\text{run} = x(B) - x(A)$. <u>Hint</u> : $x(B)$ gives you the <i>x</i> -coordinate of point <i>B</i> .
9	ABC	Insert dynamic <i>text1</i> : $\text{rise} =$ and select <i>rise</i> from <i>Objects</i> .
10	ABC	Insert dynamic <i>text2</i> : $\text{run} =$ and select <i>run</i> from <i>Objects</i> .
11		Calculate the slope of line <i>a</i> : $\text{slope} = \text{rise} / \text{run}$.
12	ABC	Insert dynamic <i>text3</i> : $\text{slope} =$ and select <i>slope</i> from <i>Objects</i> .
13		Change properties of objects in order to enhance your construction and fix text that is not supposed to be moved.



6. Dynamic Fractions and Attaching Text to Objects

Inserting dynamic fractions

Using *LaTeX* formulas, text can be enhanced to display fractions, square roots, or other mathematical symbols. Enhance your construction of the slope triangle by entering a fraction showing how to calculate the slope of a line.

1. Activate tool ABC *Text* and click on the *Graphics View*.
2. Type `slope =` into the *text* window's *Input Bar*.
3. Check *LaTeX formula* and select *Roots and Fractions a/b* from the drop-down list.
4. Place the cursor within the first set of curly braces and replace *a* by number *rise* from the *Objects* drop-down list.
5. Place the cursor within the second set of curly braces and replace *b* by number *run* from the *Objects* drop-down list.
6. Click *OK*.

Attaching text to objects

Whenever an object changes its position, attached text adapts to the movement and follows along. Enhance your construction of a slope triangle by attaching text to the sides of the slope triangle.

1. Create midpoint *D* of the vertical segment using tool $\cdot\cdot$ *Midpoint or Center*.
2. Create midpoint *E* of the horizontal segment.
3. Open the *Properties dialog* and select *text1 (rise = ...)*. Click on tab *Position* and select point *D* from the drop-down list next to *Starting Point*.
4. Select *text2 (run = ...)* in the *Properties dialog* and set point *E* as *Starting Point*.
5. Hide the midpoints *D* and *E*.

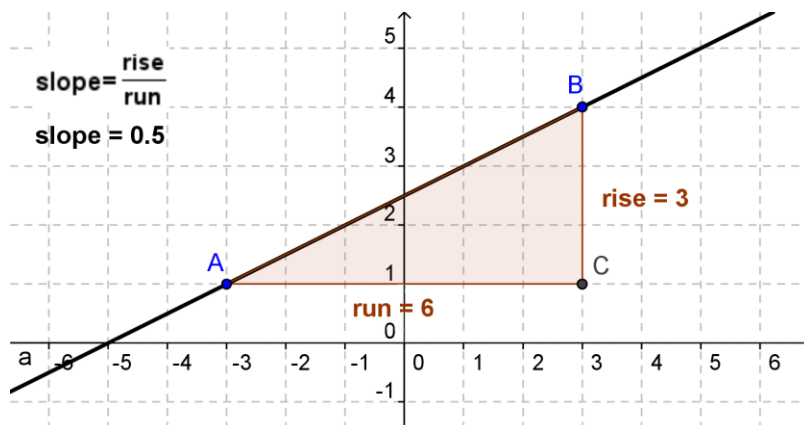



7. The mod 3 Clock



The mod 3 clock allows you to determine the remainder if you divide a given number by 3. In this dynamic figure you can create a random number between 0 and 100. Moving the blue slider causes the hand of the clock to rotate. When the value of the slider matches the given number, the hand of the clock points at the corresponding remainder for division by 3.

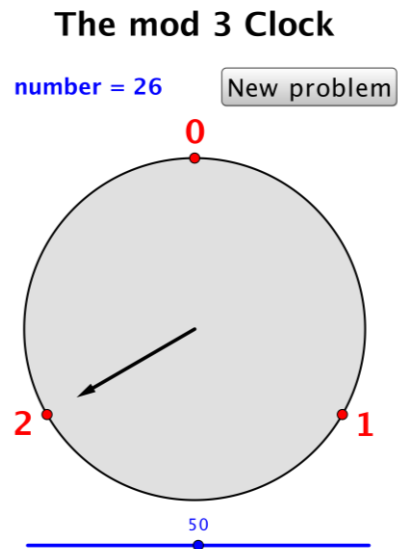

Open the link to the dynamic worksheet “The mod 3 Clock” <http://www.geogebraTube.org/student/m27287> in order to try out this unusual clock.



Preparations



- Open a new GeoGebra window.
- Switch to *Perspectives* –  *Algebra & Graphics*.

Introduction of new tools









	Ray <i>Hint:</i> The first click determines the starting point and the second click determines a point on the ray.	New!
	Button <i>Hint:</i> Click on the <i>Graphics View</i> to insert a button. Then set its caption and OnClick script in the appearing dialog.	New!

Hints: Don't forget to read the Toolbar help if you don't know how to use a tool. Try out the new tool before you start the construction.

Construction Steps

1		Create points $A = (0, 0)$ and $B = (0, 1)$.
2		Create circle c with center A through point B .
3		Zoom into the <i>Graphics View</i> .
4		Rotate point B clockwise around point A by 120° to get point B' .



5		Rotate point B clockwise around point A by 240° to get point B'_1 .
6	ABC	Create <i>text1</i> 0, <i>text2</i> 1 and <i>text3</i> 2. <u>Hint</u> : You might want to edit the text (bold, large font size).
7		Attach <i>text1</i> to point B , <i>text2</i> to point B' and <i>text3</i> to point B'_1 (<i>Properties dialog</i>).
8		Create a random number between 0 and 100: <code>number = RandomBetween[0,100]</code>
9	ABC	Create <i>text5</i> : <code>number =</code> and select <i>number</i> from <i>Objects</i> .
10	ABC	Create <i>text6</i> : The mod 3 Clock
11		Insert a button with the caption <code>New problem</code> . Enter <code>UpdateConstruction[]</code> into the <i>GeoGebraScript</i> text field. <u>Hint</u> : GeoGebra will update the construction and thus calculate a new random number each time you click on the button.
12		Create a slider n with an <i>Interval</i> from 0 to 100, <i>Increment</i> 1 and <i>Width</i> 300 (<i>Tab Slider</i>).
13		Clockwise angle BAB'_2 with given size $n \cdot 120^\circ$.
14		Ray with starting point A through point B'_2 .
15		Create a point $D = (0, 0.8)$.
16		Create a circle d with center A through point D .
17		Intersect the ray with circle d to get intersection point C .
18		Hide the ray and circle d .
19		Create a vector from A to C .
20		Change the font size of the GeoGebra window to 20 pt. <u>Hint</u> : <i>Menu Options – Font size</i>
21		Use the <i>Properties dialog</i> to enhance your construction and fix text and sliders so they can't be moved accidentally.



8. Challenge of the Day: Visualize a Binomial Formula

Check out the link to the dynamic worksheet “The Binomial Formula” <http://www.geogebraTube.org/student/m27286> It visualizes the binomial formula $(a + b)^2 = a^2 + 2ab + b^2$ and contains dynamic text that automatically adapts if the values of a and b are changed. Recreate the construction shown in the dynamic worksheet.

The Binomial Formula

Drag the **black point** in order to change the values for **a** and **b**.

Drag the **orange point** in order to change the size of the square.

$(a+b)^2 = a^2 + 2ab + b^2$
 $a = 3$
 $b = 7$
 $(a+b)^2 = 9 + 42 + 49$
 $(a+b)^2 = 100$

Hints:

- In the *Stylebar* change *Point Capturing* to *Fixed to Grid*.
- Use static text to label congruent sides of your construction and attach it to the midpoints of the corresponding sides.
- Use static text to label the areas of the different parts of the square and attach it to the center of the smaller squares / rectangles. Check the box *LaTeX formula* in order to create the ² when creating the text.
- Add dynamic text that adapts to changes of the sides a and b . If you want to color code the text you need to create a text for each term.
- Fix text that is not supposed to be moved by students (*Properties dialog*).

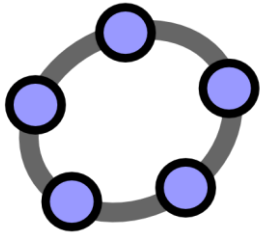

Creating and Enhancing Dynamic Worksheets with GeoGebra

GeoGebra Workshop Handout 6



1. Introduction: GeoGebraTube and User Forum

Dynamic Worksheets

GeoGebra allows you to create your own interactive instructional materials, so called *dynamic worksheets*, by exporting dynamic figures into web pages. Usually, a dynamic worksheet consists of a heading, short explanation, interactive applet, as well as tasks and directions for your students.

In order to work with dynamic worksheets your students don't need to know how to operate GeoGebra at all. The interactive web pages are independent of the software and can be provided either online or on a local storage device.

GeoGebraTube

The GeoGebraTube website (<http://www.geogebra.org/>) is a pool of free instructional materials (e.g. dynamic worksheets) created and shared by teachers from all over the world. They are grouped by different tags in order to organize their content and make them easier to access.

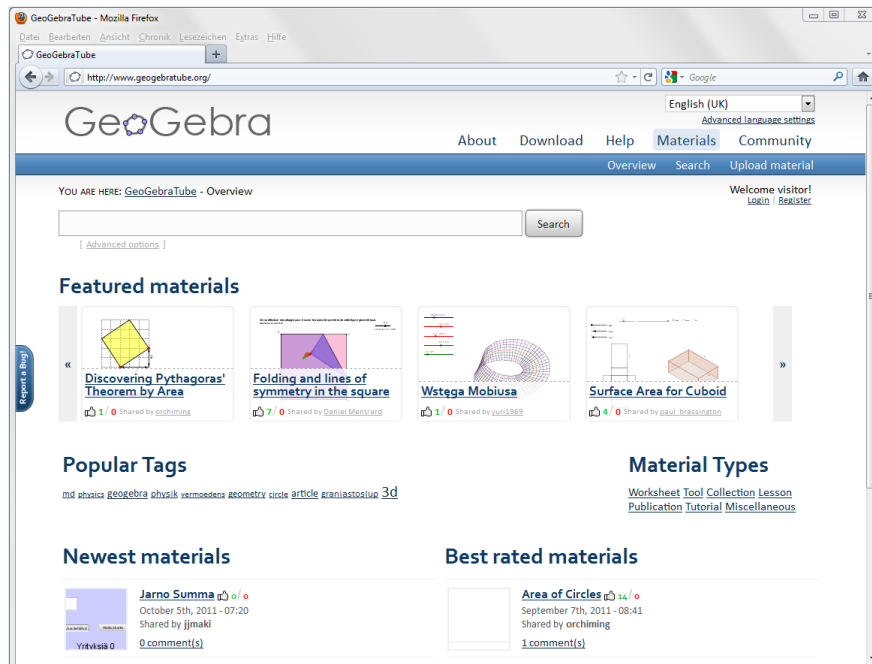

All materials on GeoGebraTube are under a Creative Common Attribution-Share Alike License (<http://creativecommons.org/licenses/by-sa/3.0/>). This means that you are allowed to use them for free and that you can create derivative work if you give credit to the original author.



GeoGebra User Forum

The GeoGebra User Forum (www.geogebra.org/forum) was created to offer additional support for the community of GeoGebra users. Created for teachers and maintained by teachers, it is a platform to pose and answer questions related to GeoGebra.

The screenshot shows the GeoGebra User Forum homepage. The browser window title is "Index page - GeoGebra User Forum - Mozilla Firefox". The address bar shows "http://www.geogebra.org/forum/". The page features the GeoGebra logo and navigation links: About, Download, Help, Materials, and Community. Below the navigation, there are links for Login, Register, FAQ, and Search. The main content area displays the forum structure:

GeoGebra User Forum

Last visit was: It is currently Wed Oct 05, 2011 8:44 am [All times are UTC + 1 hour]
[View unanswered posts](#) | [View active topics](#)

Forum	Topics	Posts	Last post
English speaking users			
Using GeoGebra Questions concerning the use of GeoGebra as a stand-alone application	1972	10458	Wed Oct 05, 2011 7:03 am Birgit Lachner →
Technological Questions Installation, dynamic worksheets, GeoGebraWiki, JavaScript, etc.	945	4428	Wed Oct 05, 2011 8:03 am rami →
German speaking users			
Bedienung von GeoGebra Fragen rund um die Bedienung von GeoGebra als Einzelanwendung	965	3836	Tue Oct 04, 2011 7:44 pm Birgit Lachner →
Technische Fragen Installation, dynamische Arbeitsblätter, GeoGebraWiki, JavaScript usw.	422	1622	Sat Oct 01, 2011 7:28 pm Birgit Lachner →
French speaking users/Utilisateurs francophones			
Français Version 3.2 Forum pour les utilisateurs de GeoGebra qui parlent français Moderators: Noel Lambert , miir	1399	9184	Tue Oct 04, 2011 3:30 pm Daniel Mentrad →
Français Version 4.0 Messages relatifs à la version 4.0 Moderators: Noel Lambert , miir	188	1104	Mon Oct 03, 2011 6:39 pm miir →
Français Version beta 4.2 (avec CAS) Moderator: miir	13	43	Tue Oct 04, 2011 6:01 pm Noel Lambert →

The GeoGebra User Forum consists of several discussion boards in different languages allowing users to post and answer their GeoGebra related questions in their native language.



2. Lower and Upper Sum



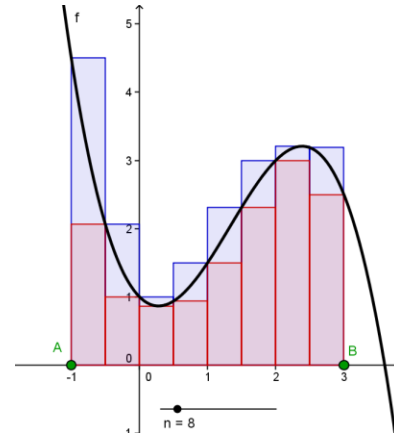

You will now learn how to create a dynamic worksheet that illustrates how lower and upper sums can be used to approximate the area between a function and the x -axis, which can be used to introduce the concept of integral to students.



Preparations

- Open a new GeoGebra window.
- Switch to *Perspectives* –  *Algebra & Graphics*.

Construction Steps

1		Enter the cubic polynomial $f(x) = -0.5x^3 + 2x^2 - x + 1$.
2		Create two points A and B on the x -axis. <u>Hint</u> : These points will determine the interval which restricts the area between the function and the x -axis.
3		Create slider for the number n with <i>Interval</i> 1 to 50 and <i>Increment</i> 1.
4		Enter <code>uppersum = UpperSum[f, x(A), x(B), n]</code> . <u>Hint</u> : <code>x(A)</code> gives you the x -coordinate of point A . Number n determines the number of rectangles used in order to calculate the lower and upper sum.
5		Enter <code>lowersum = LowerSum[f, x(A), x(B), n]</code> .
6	ABC	Insert dynamic text <code>Upper Sum =</code> and select <i>uppersum</i> from <i>Objects</i> .
7	ABC	Insert dynamic text <code>Lower Sum =</code> and select <i>lowersum</i> from <i>Objects</i> .
8		Calculate the difference <code>diff = uppersum - lowersum</code> .
9	ABC	Insert dynamic text <code>Difference =</code> and select <i>diff</i> from <i>Objects</i> .
10		Enter <code>F = Integral[f, x(A), x(B)]</code> .
11	ABC	Insert dynamic text <code>Integral =</code> and select <i>F</i> from <i>Objects</i> .



Task

Use slider n in order to modify the number of rectangles used to calculate the lower and upper sum.

1. Compare the values of the upper sum / lower sum to the value of the integral for different values of slider n . What do you notice?
2. What happens to the difference of the upper and lower sum (a) if n is small (b) if n is big?

3. Creating Dynamic Worksheets



Reducing the size of the GeoGebra window

GeoGebra will export the currently visible views (e.g. *Algebra View*, *Graphics View*,...) into the dynamic figure of the worksheet. In order to save space for explanations and tasks on the dynamic worksheet you need to make the GeoGebra window smaller prior to the export.

- If you don't want to include the *Algebra View* please hide it prior to the export.
- Move your figure (or the relevant section) to the upper left corner of the *Graphics View* using the *Move Graphics View* tool.
Hint: You might want to use the *Zoom in* and *Zoom out* tools to prepare your figure for the export process.
- Reduce the size of the GeoGebra window by dragging its lower right corner with the mouse.
Hint: The pointer will change its shape when hovering above an edge or corner of the GeoGebra window.

Note: Although the interactive applet should fit on one screen and even leave some space for text on the worksheet you need to make sure that it is big enough to allow students manipulations and experiments.

Upload to GeoGebraTube

After adjusting the size of the GeoGebra window, you are now ready to export the figure as a dynamic worksheet using the *File* menu.

- *File* – *Share...*

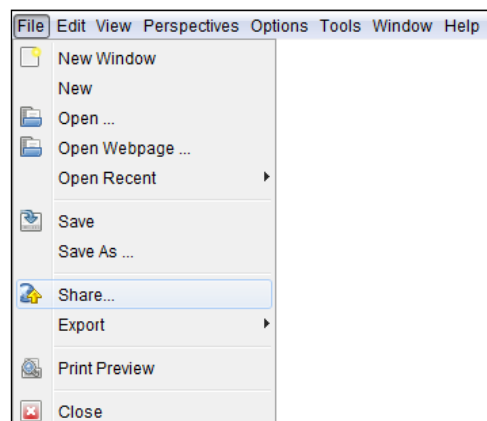



- The GeoGebraTube website opens automatically where you have to login (or register if you do not have an account yet) before you are able to continue your upload.

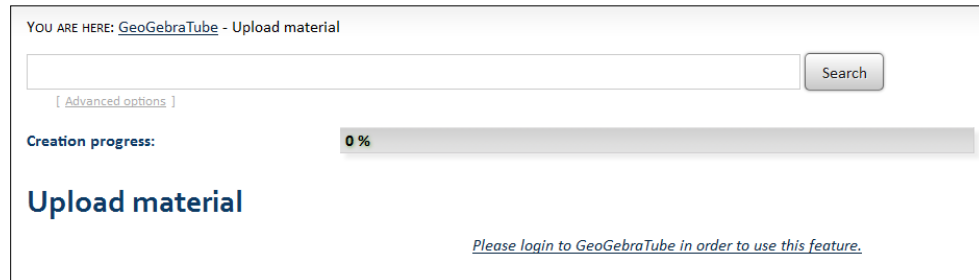

- Fill in the information for your students including specific tasks for them. If you want, you can also select to show the *Toolbar*, the *Input Bar* or the *Menubar*. Click *Continue*.
- Type a short explanation for other teachers, so that they are able to use your materials, too. This information is not shown on the student worksheet. Choose a target group and select tags that describe your material to help others with searching.
- Finish your Upload with the *Save* button.

Your worksheet is now saved on GeoGebraTube where everyone is able to use it.

Tips and Tricks for Creating Dynamic Worksheets

- After saving the dynamic worksheet it will be automatically opened up in your web browser. Check the text you inserted as well as the functionality of the interactive applet. If you want to change your dynamic worksheet go back to the GeoGebra file and make your changes to the figure. Export the figure again (you can use the same file name to overwrite the old worksheet) in order to apply your changes.
Hint: You can change the text of the dynamic worksheet in the same way.
- GeoGebra automatically saves your entries in the export window for dynamic worksheets. If you want to make changes to your figure while filling in the export dialog you can just close it and continue later on.
- Make sure your applet is not too big. Your students shouldn't have to scroll between the tasks and the figure because this makes learning more difficult.
- Your dynamic worksheet should fit on one screen. If you want to include more than 3 tasks you should consider creation of another worksheet that includes the same dynamic figure but different tasks.



Visualizing Triangle Inequalities

You will now create a dynamic worksheet that illustrates the construction steps for a triangle whose three side lengths a , b and c are given. Additionally, this worksheet will allow your students to discover triangle inequalities.

Note: The triangle inequalities $a + b > c$, $b + c > a$, and $a + c > b$ state that the sum of two side lengths of a triangle is greater than the length of the third side of the triangle. If the triangle inequalities are not fulfilled for a certain set of side lengths, it is not possible to construct a triangle using the given lengths.

Preparations

- Open a new GeoGebra window.
- Switch to *Perspectives* –



Geometry.

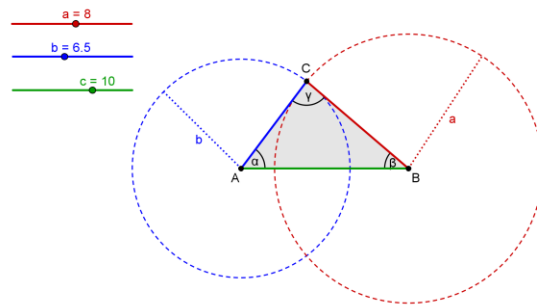

Introduction of new tools

	Segment with Given Length <i>Hint:</i> First click determines the starting point of the segment. Enter the length of the segment into the appearing text field.	New!
	Circle with Center and Radius <i>Hint:</i> First click determines the center of the circle. Enter the length of the radius into the appearing text field.	New!

Hints: Don't forget to read the Toolbar help if you don't know how to use a tool. Try out the new tools before you start the construction.

Construction Steps

1		Create sliders a , b and c for the side lengths of the triangle with an <i>Interval</i> from 0 to 10 and <i>Increment</i> 0.5.
2		Set the sliders to $a = 8$, $b = 6.5$ and $c = 10$.
3		Create segment d with given length c . <i>Hint:</i> Points A and B are the endpoints of the segment.
4		Create a circle e with center A and radius b .
5		Create a circle f with center B and radius a .



6		Construct the intersection point C of the two circles e and f .
7		Create the triangle ABC .
8		Create interior angles α , β and γ of triangle ABC .

Enhancements



Prepare your triangle construction for the export as a dynamic worksheet.

9		Create a point D on circle e .
10		Create segment g between the points A and D .
11		Construct the midpoint E of segment g .
12	ABC	Enter <i>text1</i> : b and attach it to point E .
13		Create a point F on circle f .
14		Create segment h between points B and F .
15		Construct the midpoint G of segment h .
16	ABC	Enter <i>text2</i> : a and attach it to point G .
17		Match colors of corresponding objects.
18		Show the <i>Navigation Bar</i> (right-click the <i>Graphics View</i>).
19		Open the <i>Construction Protocol</i> (menu <i>View</i>).
20		Show the column <i>Breakpoint</i> .
21		Change the order of construction steps so that the radius of the circles and the attached text show up at the same time. <u>Hint</u> : You might also set some other breakpoints (e.g. show all sliders at the same time).
22		Now check <i>Show Only Breakpoints</i> .



Tasks

(a) Export your triangle construction as a dynamic worksheet.

(b) Come up with explanations and tasks for your students that guide them through the construction process of the triangle and help them explore the triangle inequalities by modifying the given side lengths using the sliders.

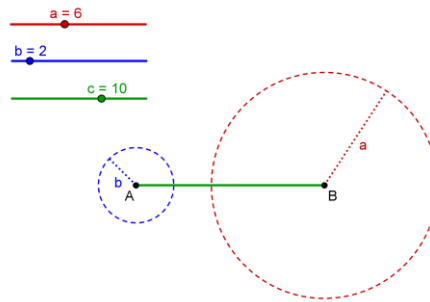

4. Design Guidelines for Dynamic Worksheets

The following design guidelines for dynamic worksheets are the result of a formative evaluation of dynamic worksheets created by teachers in our NSF MSP classes during fall 2006 and spring 2007. The guidelines are based on design principles for multimedia learning stated by Clark and Mayer¹.

These guidelines were summarized to address and avoid common mistakes during the creation process of dynamic worksheets as well as to increase their quality with the hope that they will foster more effective learning. Although some of these guidelines may seem obvious, we have found it very important in our work with teachers to discuss and explain them in detail.

The following figure shows a dynamic worksheet created with GeoGebra that allows students to explore properties of the orthocenter of a triangle. By modifying the dynamic construction students can examine the orthocenter of a great variety of triangles instead of just one special case. Several key words within the explanation and tasks match the color of the corresponding objects in order to facilitate finding them within the construction. Furthermore, the tasks are placed next to the dynamic construction in order to fit all information on one screen and avoid additional cognitive load through scrolling.

¹ Clark, R. and Mayer, R.E. (2002): e-Learning and the Science of Instruction. San Francisco: Pfeiffer, 2002



Orthocenter of a Triangle

Below you can see a triangle ABC together with its heights. The intersection point of the three heights is called **orthocenter** of the triangle.

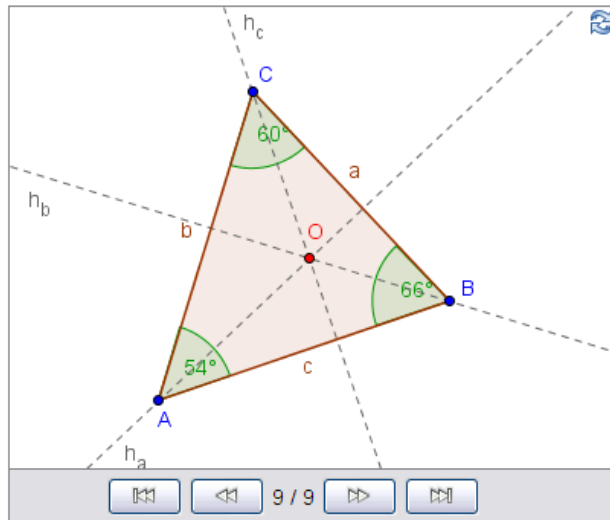

Created with [GeoGebra](https://www.geogebra.org/)

1. How do you construct the **orthocenter** of a triangle? Write down detailed construction steps on paper. **Hint:** You can use the arrow buttons to redo the construction.
2. You can modify the shape of the triangle by dragging its **vertices** with the mouse. Thereby, the **orthocenter** and **angles** change too. Try to find the position of the orthocenter if
 - a) all angles are acute.
 - b) one angle is obtuse.
 - c) one angle is a right angle.

Design Guidelines 1: Layout of Dynamic Worksheets

Avoid scrolling

Your entire worksheet should fit on one screen. Students should not have to scroll between the tasks and the interactive figure. We consider 1024x768 or 1280x1024 pixels as today's usual screen size which constrains the size of the dynamic worksheet. Using an HTML editor like NVU you can use tables to arrange text, images and interactive figures so they fit on one screen. If this is not possible, consider breaking the dynamic worksheet into several pages.

Short explanation

At the beginning of a dynamic worksheet, you should give an explanation of its content. Keep the text short (no more than one or two sentences) and write it in a personal style.

Few tasks

You will usually add questions or tasks to make sure that your students use the worksheet actively. Place these tasks close to the interactive applet (e.g. directly below it). Don't use more than three or four questions / tasks to avoid scrolling. If you have more tasks, consider breaking your worksheet into several pages.



Avoid distractions

Make sure that your dynamic worksheet just contains objects that are relevant for the objectives. Neither use unnecessary background or purely decorative images, nor background music on the web page in order not to distract your students from reaching the objectives.

Design Guidelines 2: Dynamic Figures

Interactivity

Allow as much interactivity as possible in your dynamic figure. As a rule of thumb, all visible objects should be movable or changeable in some way. Your dynamic figure should provide plenty of freedom to explore the relations of its mathematical objects and discover mathematical concepts.

Easy-to-use

Try to make your dynamic figure as easy to use as possible. If an object can be moved or changed, try to make this obvious, e.g. all movable points could be red or larger in size. If you don't want objects to be changed, fix them (e.g. text, functions or slider positions) so they cannot be moved accidentally.

Size matters

Your dynamic figure should be large enough to allow all intended manipulations, but small enough to fit on one screen and still leave sufficient space for explanations and questions on the surrounding web page.

Use dynamic text

Dynamic text, like the length of a changeable segment, should be placed close to the corresponding object in your applet.

Avoid static text

Too much text can easily clutter your interactive applet. Instead, place static text like explanations or questions on the web page that includes your dynamic figure.

First appearance

When a dynamic worksheet is opened you should be able to read all labels and important information. For example, a point label should not be crossed by a line.



Design Guidelines 3: Explanations and Tasks

Short, clear and personal style

Try to write your explanations and questions in a short, clear and conversational style. Use the term 'you' within the text and try to address the students directly.

Small number of questions

Limit your number of questions or tasks per worksheet to three or four to avoid scrolling. If you want to ask more questions, create a new worksheet.

Use specific questions

Avoid general questions like 'What is always true about X?' and make clear what the students should do, e.g. 'What happens to X when you move Y?'. We recommend that your students should take notes while they work with a dynamic worksheet. If you want them to write down their answers on paper, say so on the worksheet.

Refer to your applet

Your text should support the use of your interactive applet. For example, try to explain a new term by referring to your applet instead of using an isolated textual definition. Additionally, you can color certain keywords to match the formatting style of the object they refer to. This makes the text easier to read and helps your students to find corresponding representations of the same object.

Your audience are learners

If you want to provide information for other educators (e.g. lesson plan, solutions) do so in a separate document (e.g. web page, pdf-document). Your students should not be distracted or confused by such information.

Demonstration figure

If your interactive figure is meant for presentation only it might be better to have no tasks or questions on the web page. If you include text, it should be understandable for students as well.



5. Creating a 'Tangram' Puzzle



In this activity you will create the 'Tangram' puzzle shown at the right hand side. It consists of 7 geometric shapes which can all be constructed using the side length a of the main square. Check out the link to the dynamic worksheet <http://www.geogebraTube.org/student/m27289> "Tangram' Puzzle" in order to find out how a 'Tangram' works.

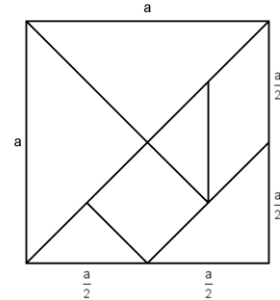



Task 1: Figure out the side lengths of each part

In order to construct the parts of the 'Tangram' puzzle you need to figure out the individual side lengths of the seven geometric figures first. They all depend on the side length a of the main square.

Hint: In some cases you might want to look at the diagonals or height. Their lengths can be expressed more easily using the variable a than the lengths of the corresponding sides.

Task 2: Construct the individual parts of the 'Tangram'

1. Enter the number $a = 6$. It will provide a basis for the construction of all triangles and quadrilaterals necessary for your 'Tangram' puzzle.
2. Construct the geometric shapes using one of the tools  *Segment With Given Length* or  *Rigid Polygon*. This will allow you to drag and rotate the shape later on.

Hint: You need to figure out the side lengths of the geometric shapes before you are able to construct them in GeoGebra.
3. Construction hints:
 - a. If the height of a right triangle is half the length of the hypotenuse you might want to use the theorem of Thales for the construction (see Workshop Handout 2, Chapter 4).
 - b. If you know the legs of a right triangle you might want to construct it similar to the square construction presented earlier.
 - c. For constructing a square using its diagonals, it is helpful to know that they are perpendicular and bisect each other.
 - d. For constructing the parallelogram it is helpful to know the size of the acute angle.
4. Check your construction by trying out if you can manage to create a square with side length a using all figures.
5. Arrange the geometric shapes arbitrarily around the edges of the interactive applet. Export the figure to a dynamic worksheet and add an explanation for your students.



6. Challenge of the Day: Enhance Your 'Tangram' Puzzle

With these geometric shapes other figures than a square can be created as well. Search the Internet for a 'Tangram' figure other than a square (e.g. http://www.geogebra.org/book/intro-en/worksheets/tangram_cat.png) and import this figure into the *Graphics View*. Export the GeoGebra construction again using a different name and different instructions (see <http://www.geogebraTube.org/student/m27288>).



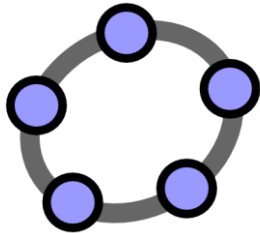

Custom Tools and Customizing the Toolbar

GeoGebra Workshop Handout 7









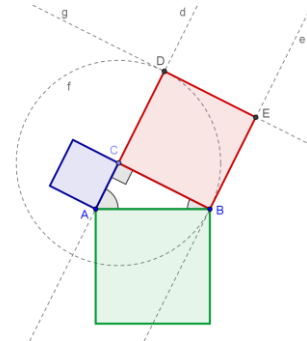







1. The Theorem of Pythagoras

Preparations

- Open a new GeoGebra window.
- Switch to *Perspectives* –  *Geometry*.
- Change the labeling setting to *New Points Only* (menu *Options* – *Labeling*).



Construction Steps

1		Create segment a with endpoints AB .
2		Create semicircle c through points A and B .
3		Create a new point C on the semicircle. <u>Hint</u> : Check if point C really lies on the arc by dragging it with the mouse.
4		Hide the segment and the semicircle.
5		Construct a triangle ABC in counterclockwise direction.
6		Rename the triangle sides to a , b and c .
7		Create interior angles of triangle ABC . <u>Hint</u> : Click in the middle of the polygon to create all angles.
8		Drag point C to check if your construction is correct.
9		Create a perpendicular line d to segment BC through point C .
10		Create a perpendicular line e to segment BC through point B .
11		Create a Circle f with center C through point B .
12		Intersect the circle f and the perpendicular line d to get intersection point D .
13		Create a parallel line g to segment BC through point D .
14		Create intersection point E of lines e and g .
15		Create the square $CBED$.



16		Hide the auxiliary lines and circle.
17		Repeat steps 8 to 15 for side AC of the triangle.
18		Repeat steps 8 to 15 for side AB of the triangle.
19		Drag the vertices of the right triangle to check if your squares are correct.
20		Enhance your construction using the <i>Stylebar</i> .

Enhancing the construction

Insert static and dynamic text into your construction that helps to understand the Pythagorean theorem $a^2 + b^2 = c^2$ where a and b are the legs and c is the hypotenuse of a right triangle.

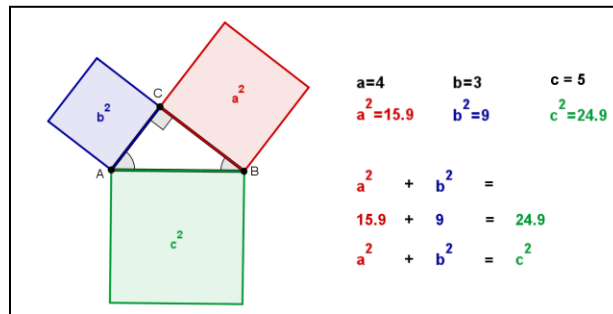

Introduction of new tool

	Copy Visual Style	New!
<u>Hint:</u> Click on an object to copy its visual style. Then, click on other objects to match their visual style with the first object.		

Hints: Don't forget to read the Toolbar help if you don't know how to use the tool. Try out the new tool before you start the construction.

Construction Steps

21		Create the midpoints of all three squares. <u>Hint:</u> Click on diagonal opposite vertices of each square.
22	ABC	Insert static <i>text1</i> : a^2 and attach it to the midpoint of the corresponding square. <u>Hint:</u> Don't forget to check the box LaTeX formula to get a^2 .
23	ABC	Insert static <i>text2</i> : b^2 and attach it to the midpoint of the corresponding square.



24		Insert static <i>text3</i> : c^2 and attach it to the midpoint of the corresponding square.
25		Hide the midpoints of the squares.
26		Format the text to match the color of the corresponding squares.
27		Insert text that describes the Pythagorean theorem.
28		Export your construction as a dynamic worksheet. Come up with an explanation that helps your students understand the theorem of Pythagoras.

2. Creating Custom Tools



GeoGebra allows you to create custom tools. This means that you can extend the Toolbar by creating your own tools. Let's now create a tool that determines the minimal distance between a line and a point (e.g. altitude in a triangle). Before you can create your custom tool you need to construct all the objects required for your tool.

Prepare the construction

Preparations

- Open a new GeoGebra window.
- Switch to *Perspectives* – *Geometry*.
- Change the labeling setting to *All New Objects* (menu *Options* – *Labeling*).

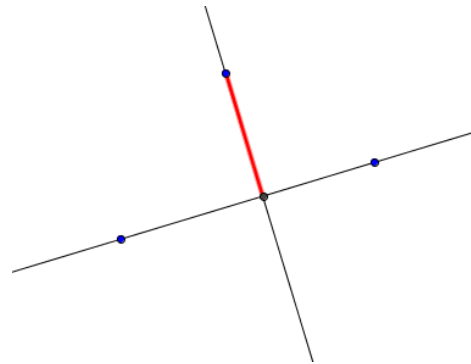

Construction Steps

1		Create line <i>a</i> through two points <i>A</i> and <i>B</i> .
2		Insert a new point <i>C</i> .
3		Create perpendicular line <i>b</i> to line <i>a</i> through point <i>C</i> .
4		Construct intersection point <i>D</i> of lines <i>a</i> and <i>b</i> .
5		Create segment <i>c</i> between points <i>C</i> and <i>D</i> .
6		Drag points <i>A</i> , <i>B</i> and <i>C</i> to check your construction.
7		Change the color of segment <i>c</i> and hide the labels of all objects.



Create a custom tool

1. In menu *Tools* click on  *Create New Tool...* to open the *Create New Tool* dialog.
2. By default, tab *Output Objects* is activated.
3. Specify the output objects of your new tool by either clicking on the desired output object on the drawing pad (our example: segment *c*) or selecting it from the drop down menu (click on the little arrow next to the input field).
4. Click the *Next >* button in order to activate tab *Input Objects*.
5. GeoGebra fills in the corresponding input objects for your tool automatically (our example: points *A*, *B* and *C*).
Note: GeoGebra picks all so-called 'parent objects' of the output objects you specified.
6. Click the *Next >* button in order to activate tab *Name & Icon*.
7. Fill in a name for your tool and text for the *Toolbar help*.
Note: GeoGebra fills in the text field *Command name* automatically.
8. Click the button *Finish*.

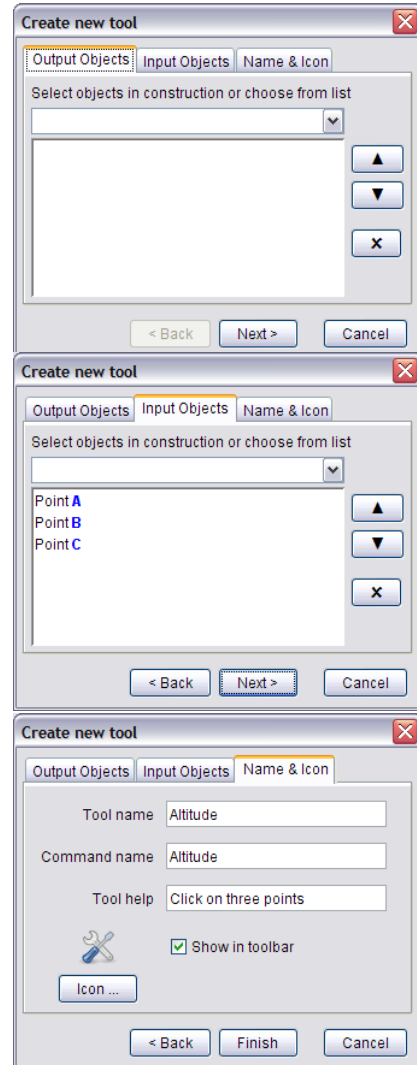

Hint: Your new tool is now part of the GeoGebra Toolbar.

Try out your custom tool

1. Open a new GeoGebra window using menu *File – New*.
Note: Your custom tool is still part of the *Toolbar*.
2. Create a triangle *ABC* using tool *Polygon*.
3. Activate your custom tool *Altitude*.
4. Click on points *A*, *B* and *C* in order to create one of the triangle's altitudes.
5. Create another altitude of the triangle.
6. Intersect the two altitudes to get the orthocenter of the triangle.

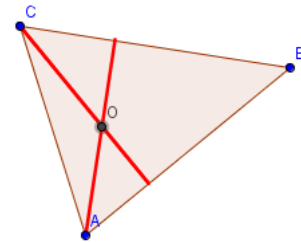



3. Saving and Importing Custom Tools

Save your custom tool

1. In menu *Tools* click on  *Manage tools...* to open the *Manage tools* dialog window.
2. Select your custom tool *Altitude* from the list of available tools.
3. Click on button *Save as...* in order to save your custom tool and make it available for future constructions.
4. Choose a name for your custom tool (e.g. *Altitude_tool.ggt*) and save it on your computer.

Hint: Custom GeoGebra tools are saved with the file name extension *.ggt*. This helps you to distinguish between 'usual' GeoGebra files (extension *.ggb*) and custom tool files.

Import a custom tool

After saving your custom tool you are able to reuse it in future constructions. By default the GeoGebra Toolbar doesn't include any custom tools. In order to reuse one of your custom tools you need to import it into your new GeoGebra window.

1. Open a new GeoGebra window.
2. In menu *File* click on  *Open*.
3. Look for the custom tool you saved earlier (e.g. *Altitude_tool.ggt*) and select it from the list of available GeoGebra files (*.ggb*) and tool files (*.ggt*).
4. Click the *Open* button to import your custom tool into the Toolbar of the new GeoGebra window.

Hint: Importing a custom tool doesn't affect the construction in your GeoGebra window. Thus, you can also import custom tools during a construction process.



4. Creating a Square Tool







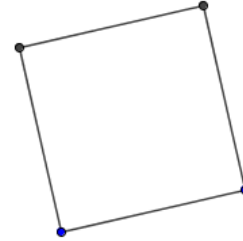





Preparations

- Open a new GeoGebra window.
- Switch to *Perspectives* –  *Geometry*.
- Change the labeling setting to *All New Objects* (menu *Options* – *Labeling*).



Construction Steps

1		Create segment a with endpoints AB .
2		Create perpendicular line b to segment AB through point B .
3		Create a circle c with center B through point A .
4		Intersect circle c and perpendicular line b to get intersection point C .
5		Construct a parallel line d to perpendicular line b through point A .
6		Construct a parallel line e to segment a through point C .
7		Intersect lines d and e to get intersection point D .
8		Create the square $ABCD$.
9		Hide auxiliary objects (lines and circle).
10		Hide labels of all objects (<i>Stylebar</i>).
11		Set the square's color to black and set the <i>Opacity</i> to 0%.
12		Create your square tool (menu <i>Tools</i> – <i>Create New Tool...</i>). <u>Output objects</u> : square, sides of the square, points C and D <u>Input objects</u> : points A and B <u>Name</u> : Square <u>Toolbar help</u> : Click on two points
13		Save your square tool as file <i>Square_Tool.ggt</i> <u>Hint</u> : Menu <i>Tools</i> – <i>Manage Tools...</i> – <i>Save as...</i>

Task

Compare the construction process of this square with the one you used in workshop 2. What are the differences?



5. The Fibonacci Spiral



A *Fibonacci spiral* can be created by drawing arcs connecting the opposite corners of squares in the Fibonacci tiling which uses squares of sizes 1, 1, 2, 3, 5, 8, 13, 21,...

The *Fibonacci spiral* approximates the so called *Golden Spiral* which is a logarithmic spiral whose growth factor is related to the golden ratio.

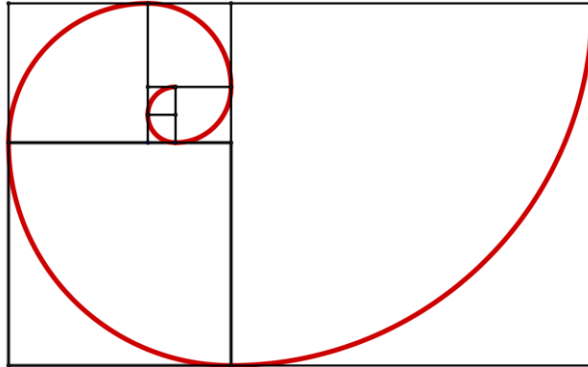

Preparations



- Open a new GeoGebra window.
- Switch to *Perspectives* –  *Geometry*.
- Import your Square tool into the Toolbar (menu *File – Open*).
- Change the labeling setting to *No New Objects* (menu *Options – Labeling*).

Introduction of new tool



	Circular Arc	New!
<p><u>Hint:</u> Click on the center point of the circular arc. Then, specify two points that determine the radius and length of the arc.</p>		

Hints: Don't forget to read the Toolbar help if you don't know how to use the tool. Try out the new tool before you start the construction.

Construction Steps

1		<p>Use your Square tool to create a square with side length 1.</p> <p><u>Hint:</u> Place the two points on grid points that are next to each other.</p>
2		<p>Create a second square with side length 1 below the first square.</p> <p><u>Hint:</u> Use already existing points to connect both squares.</p>
3		<p>Create a third square with side length 2 on the right hand side of the two smaller squares.</p>



4		Continue creating squares with side lengths 3, 5, 8 and 13 in counter clockwise direction.
5		Create a circular arc within the first square you created. <u>Hint</u> : Specify the lower right vertex of the square as the center of the arc. Select two opposite vertices of the square in counter clockwise orientation.
6		Repeat step 5 for each of the squares in order to construct the Fibonacci spiral.
7		Enhance your construction using the <i>Stylebar</i> .

6. Constructing the Center of a Circle



Back to school...

Do you know how to construct the center of a circle?

Print the page with circles at the end of this chapter and try to find a way of finding the center of these circles (a) only by folding the paper and (b) with pencil and ruler.

Hints:

- Version 1a: Fold two circle diameters which intersect in the circle's center.
- Version 1b: Can you recreate this construction using pencil and ruler?
- Version 2a: Fold two chords of the circle as well as their perpendicular bisectors which intersect in the center of the circle.
- Version 2b: Can you recreate this construction using pencil and ruler?

Now use GeoGebra in order to recreate the construction you used in version 2b.

Preparations

- Open a new GeoGebra window.
- Switch to *Perspectives* –  *Geometry*.
- Show the *Input Bar* (*View* menu).

Construction Steps

1		Enter circle c 's equation: $x^2 + y^2 = 16$.
2		Create chord a of circle c . <u>Hint</u> : A chord is a segment whose endpoints both lie on the circle.



3		Create midpoint C of chord a .
4		Create perpendicular line b to the chord a through point C . <u>Hint:</u> You just created the perpendicular bisector of chord a .
5		Create another chord d of circle c .
6		Create midpoint F of chord d .
7		Create perpendicular line e to chord d through point F .
8		Intersect lines b and e to get intersection point G . <u>Hint:</u> Point G is the center of circle c .
9		Enhance your construction using the <i>Stylebar</i> .
10		Check your construction for different positions of the chords.

Tasks

- Right-click (MacOS: *Ctrl-click*) the *Graphics View* and show the *Navigation Bar* to review the construction steps.
- Open the *Construction Protocol* (menu *View*) and show the column *Breakpoint* to group some of the objects you used. After specifying your breakpoints, check *Show Only Breakpoints*.
- Export the construction as a dynamic worksheet that includes the *Navigation Bar* (*Export* dialog – tab *Advanced*) and save the file as *Center_Circle_Solution.html*.
- Open the dynamic worksheet you just exported. Use the *Navigation Bar* to review your construction and write down which tools you used in order to construct the center of the circle.

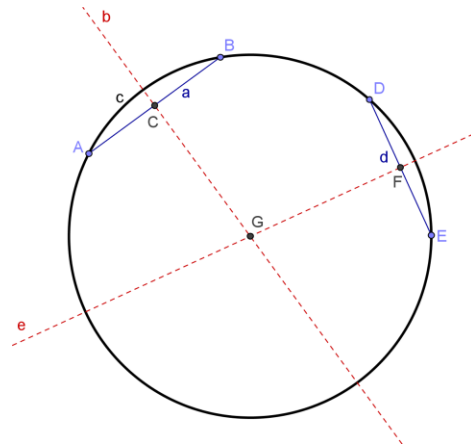



7. Customizing the Toolbar

You will now learn how to customize GeoGebra's Toolbar so you can limit the number of available tools for your students.

1. In the *Tools* menu click on *Customize Toolbar...*
2. At the top of the window you can choose different default Toolbars (General, Spreadsheet, CAS and Data Analysis) from the drop-down menu.
3. The window on the left hand side lists all GeoGebra tools that are part of the chosen Toolbar. If you click on one of the + symbols in front of the tool names the corresponding toolbox is opened.
4. In the left hand side list click on the + symbol in front of the *Move* tool to open the toolbox. Select tool *Move around Point* and click the *Remove>* button. Then select tool *Record to Spreadsheet* and click the *Remove>* button again. The *Move* tool will now be the only tool left in the toolbox *Move*.
5. Now open the next toolboxes and remove all tools except those, you need to construct a circle's center (*Intersect*, *Midpoint or Center*, *Segment*, *Perpendicular Line*).
6. Use the *Up* and *Down* buttons to change the order of the tools in the left hand side list.
7. Click *Apply* once you are done.
8. Your GeoGebra window should now show the customized Toolbar.

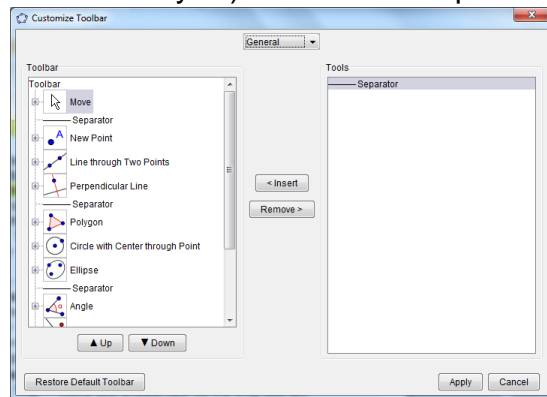

Task

- Delete all objects apart from the circle.
- Export this updated construction as a dynamic worksheet that includes the customized Toolbar and shows the Toolbar help (*Export* dialog – tab *Advanced*).
- Save the dynamic worksheet as *Center_Circle_Construction.html*.



8. Challenge of the Day: Euler's Discovery

Task

- Construct the following three 'remarkable' points of a triangle: circumcenter, orthocenter and centroid. Create a custom tool for each of these points. Save your custom tools.
- Use your custom tools within one construction to find the relation between these three points as the Swiss mathematician Euler did in the 18th century, obviously without having access to dynamic geometry software ;-)





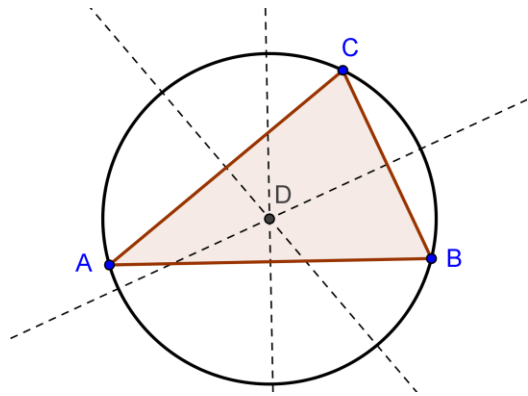

Circumcenter of a Triangle

Preparations

- Open new GeoGebra window.
- Switch to *Perspectives - Geometry*.
- Change the labeling setting to *New Points Only* (menu *Options – Labeling*).



Construction Steps

1	 Create an arbitrary triangle ABC .
2	 Create perpendicular bisectors d , e and f for all sides of the triangle. <u>Hint:</u> The tool <i>Perpendicular Bisector</i> can be applied to an existing segment.
3	 Construct intersection point D of the two of the line bisectors.
4	 Create a circle with center D through one of the vertices of triangle ABC .
5	 Rename point D to <i>Circumcenter</i> .
6	 Use the drag test to check if your construction is correct.
7	 Create a custom tool for the circumcenter of a triangle. <u>Output objects:</u> point <i>Circumcenter</i> <u>Input objects:</u> points A , B and C <u>Name:</u> Circumcenter <u>Toolbar help:</u> Click on three points
8	Save your custom tool as file <i>circumcenter.ggt</i> .







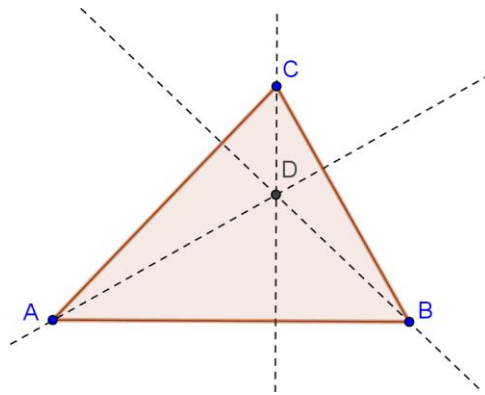

Orthocenter of a Triangle

Preparations

- Open new GeoGebra window.
- Switch to *Perspectives* –  *Geometry*.
- Change the labeling setting to *New Points Only* (menu *Options* – *Labeling*).



Construction Steps

1	 Create an arbitrary triangle ABC .
2	 Create perpendicular lines d , e and f to each side through the opposite vertex of the triangle.
3	 Construct intersection point D of two of the perpendicular lines.
4	 Rename point D to <i>Orthocenter</i> .
5	 Use the drag test to check if your construction is correct.
6	 Create a custom tool for the orthocenter of a triangle. <u>Output objects</u> : point <i>Orthocenter</i> <u>Input objects</u> : points A , B and C <u>Name</u> : Orthocenter <u>Toolbar help</u> : Click on three points
7	Save your custom tool as file <i>orthocenter.ggt</i> .

Centroid of a Triangle

Preparations



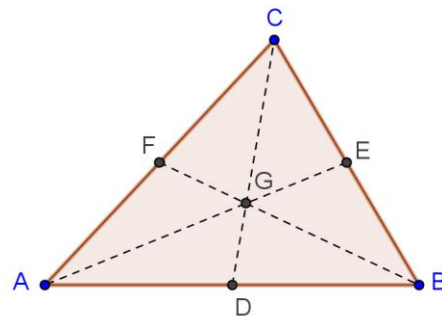



- Open new GeoGebra window.
- Switch to *Perspectives* –  *Geometry*.
- Change the labeling setting to *New Points Only* (menu *Options* – *Labeling*).



Construction Steps

1	 Create an arbitrary triangle ABC .
---	--



2		Create midpoints D , E and F of the triangle sides.
3		Connect each midpoint with the opposite vertex using segments d , e and f .
4		Create intersection point G of two of the segments.
5		Rename point G to <i>Centroid</i> .
6		Use the drag test to check if your construction is correct.
7		Create a custom tool for the centroid of a triangle. <u>Output objects:</u> point <i>Centroid</i> <u>Input objects:</u> points A , B and C <u>Name:</u> Centroid <u>Toolbar help:</u> Click on three points
8		Save your custom tool as file <i>centroid.ggt</i> .

What was Euler's discovery?

Task 1

- Open a new GeoGebra window and import your three custom tools (*circumcenter.ggt*, *orthocenter.ggt* and *centroid.ggt*) into the Toolbar.
- Create an arbitrary triangle ABC and apply all three custom tools to the triangle in order to create the circumcenter, orthocenter and centroid within the same triangle.
- Move the vertices of triangle ABC and observe the three 'remarkable' points you just constructed. Which relationship do they have? Use one of GeoGebra's geometry tools in order to visualize this relationship.

Task 2

- Open an empty GeoGebra window. Customize the Toolbar so it only consists of the following tools: *Move*, *Polygon*, *Line*, *Circle with Center through Point*, *Circumcenter*, *Orthocenter* and *Centroid*.
- Export this empty GeoGebra window as a dynamic worksheet that includes the customized Toolbar as well as the Toolbar help. Come up with instructions that guide your students towards discovering the Euler line in a triangle.



Constructing the Center of a Circle Worksheet

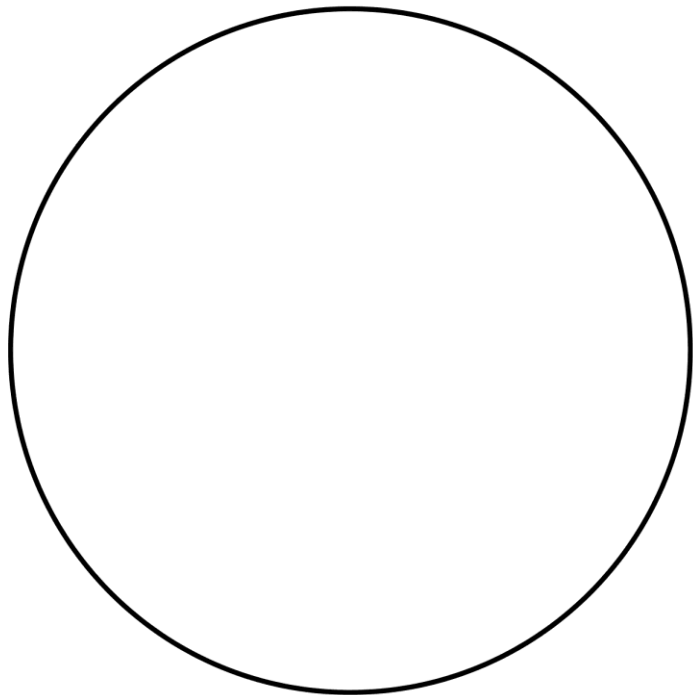
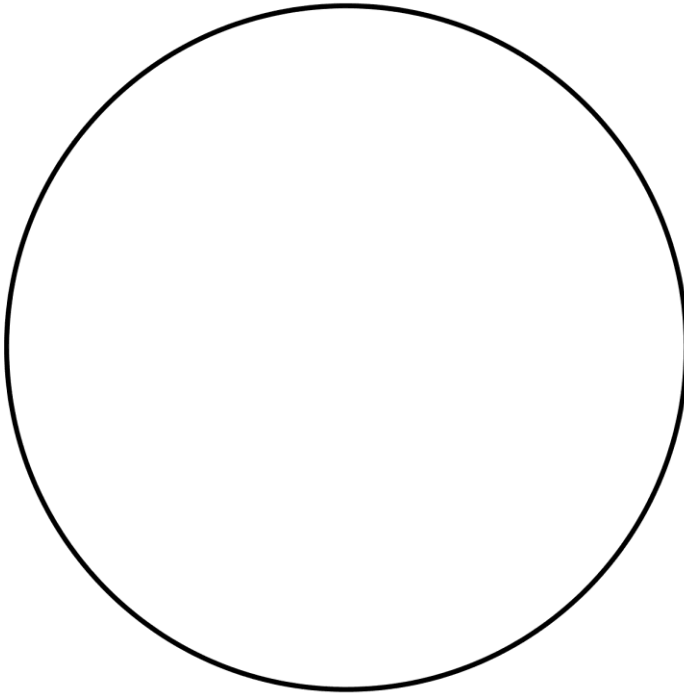

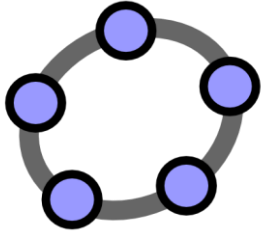

Conditional Visibility & Sequences

GeoGebra Workshop Handout 8



1. Visualizing Integer Addition on the Number Line





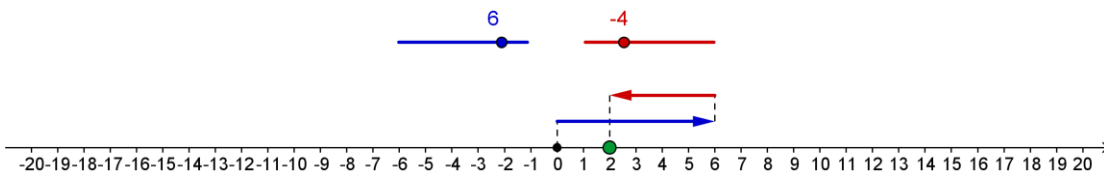

Preparations







- Open a new GeoGebra window.
- Switch to *Perspectives* –  *Geometry*.
- Show the *Input Bar* (*View* menu).
- In the *Options* menu set *Labeling* to *All New Objects*.



Construction Steps

1	Open the <i>Properties dialog</i> for the <i>Graphics View</i> . <u>Hint:</u> Choose  <i>Preferences</i> and then  <i>Graphics</i> .
2	On tab <i>xAxis</i> set the distance of tick marks to 1 by checking the box <i>Distance</i> and entering 1 into the text field.
3	On tab <i>Basic</i> set the <i>minimum</i> of the x-Axis to -21 and the <i>maximum</i> to 21.
4	On tab <i>yAxis</i> uncheck <i>Show yAxis</i> .
5	Close the <i>Properties dialog</i> for the <i>Graphics View</i> .
6	 Create a slider for number a with <i>Interval</i> -10 to 10 and <i>Increment</i> 1.
7	 Create a slider for number b with <i>Interval</i> -10 to 10 and <i>Increment</i> 1.
8	Show the value of the sliders instead of their names. <u>Hint:</u> <i>Stylebar</i> - <i>Set label style</i> - <i>Value</i>
9	 Create point $A = (0, 1)$.
10	Create point $B = A + (a, 0)$. <u>Hint:</u> The distance of point B to point A is determined by slider a .



11		Create a vector $u = \text{Vector}[A, B]$ which has the length a .
12		Create point $C = B + (0, 1)$.
13		Create point $D = C + (b, 0)$.
14		Create vector $v = \text{Vector}[C, D]$ which has the length b .
15		Create point $R = (x(D), 0)$. <u>Hint:</u> $x(D)$ gives you the x -coordinate of point D . Thus, point R shows the result of the addition on the number line.
16		Create point $Z = (0, 0)$.
17		Create segment $g = \text{Segment}[Z, A]$.
18		Create segment $h = \text{Segment}[B, C]$.
19		Create segment $i = \text{Segment}[D, R]$.
20		Use the <i>Properties dialog</i> to enhance your construction (e.g. match the color of sliders and vectors, line style, fix sliders, hide labels).

Insert dynamic text

Enhance your interactive figure by inserting dynamic text that displays the corresponding addition problem. In order to display the parts of the addition problem in different colors you need to insert the dynamic text step by step.

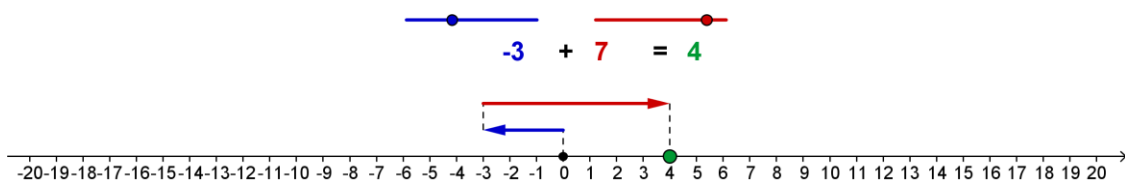

1		Calculate the result of the addition problem: $r = a + b$
2	ABC	Insert dynamic <i>text1</i> : a
3	ABC	Insert static <i>text2</i> : $+$
4	ABC	Insert dynamic <i>text3</i> : b
5	ABC	Insert static <i>text4</i> : $=$





6	ABC	Insert dynamic <i>text5</i> : r
7		Match the color of <i>text1</i> , <i>text3</i> and <i>text5</i> with the color of the corresponding sliders, vectors and point <i>R</i> .
8		Line up the text on the <i>Graphics View</i> .
9		Hide the labels of the sliders and fix the text (<i>Properties dialog</i>).
10		Export your interactive figure as a dynamic worksheet.



2. Animating Constructions

GeoGebra offers the possibility to animate sliders (numbers, angles) and points on paths (segment, line, function, curve, etc.). While an animation is running, GeoGebra remains fully functional. This allows you to make changes to your construction while the animation is playing.

Construction Steps

1	Open the GeoGebra file you created in the previous activity.
2	Right-click (MacOS: <i>Ctrl-click</i>) slider <i>a</i> and choose <i>Animation On</i> from the appearing context menu. <u>Hint</u> : an animation button appears in the lower left corner of the <i>Graphics View</i> . It allows you to either  pause or  continue an animation.
3	Right-click (MacOS: <i>Ctrl-click</i>) slider <i>b</i> and choose <i>Animation On</i> from the appearing context menu. <u>Hint</u> : In order to stop the animation of this slider, you can un-check <i>Animation On</i> in the context menu.
4	Open the <i>Object Properties dialog</i> for slider <i>a</i> and <i>b</i> and choose tab <i>Slider</i> . There you can change the behavior of the animation (see details below). Try out different settings for the sliders and determine the impact of the animation on the result <i>r</i> .

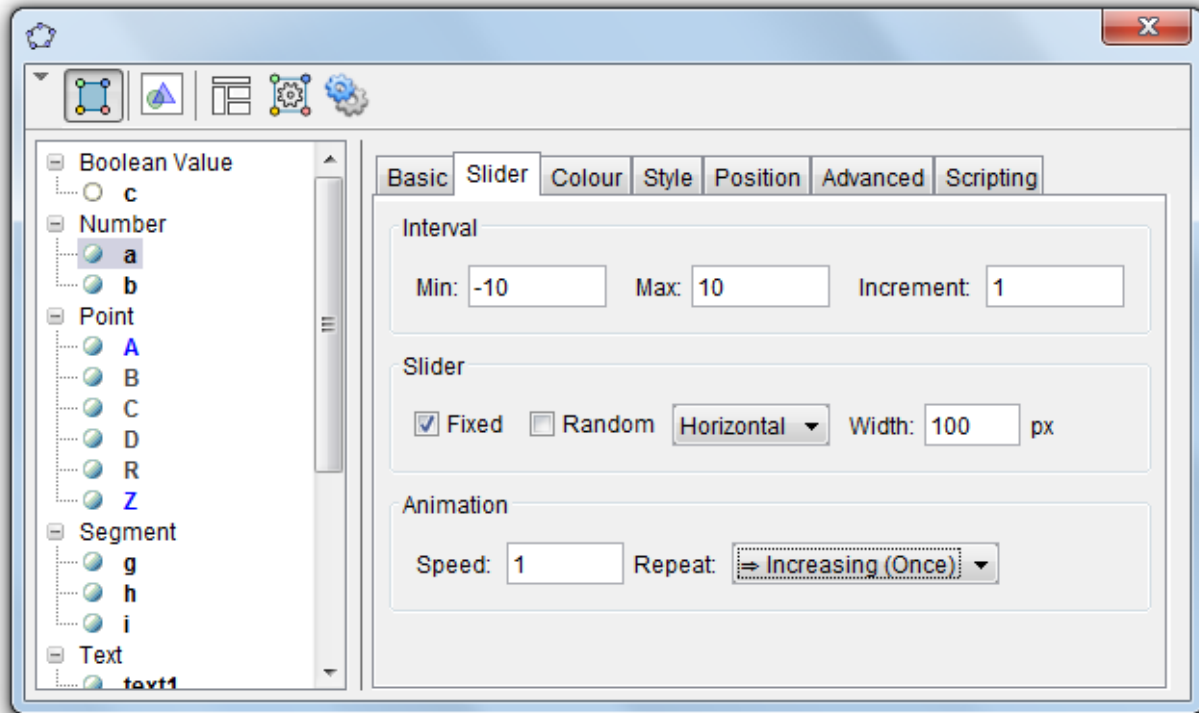

In the *Object Properties dialog* you can change the behavior of your animation:

Speed: A speed of 1 means that the animation takes about 10 seconds to run through the slider interval once.

Repeat:

↔ Oscillating

The animation cycle alternates between Decreasing and Increasing.

⇒ Increasing

The slider value is always increasing. After reaching the maximum value of the slider, it jumps back to the minimum value and continues the animation.

⇐ Decreasing

The slider value is always decreasing. After reaching the minimum value of the slider, it jumps back to the maximum value and continues the animation.

⇒ Increasing (Once)

The slider value is increasing. After reaching the maximum value of the slider, the animation stops.



3. Conditional Formatting – Inserting Checkboxes





Introduction of new tool

	Check Box	New!
<p><u>Hint:</u> Click on the <i>Graphics View</i> to open the checkbox dialog window. Enter a caption and select the objects you want to show / hide using the checkbox from the drop down menu.</p>		

Construction Steps

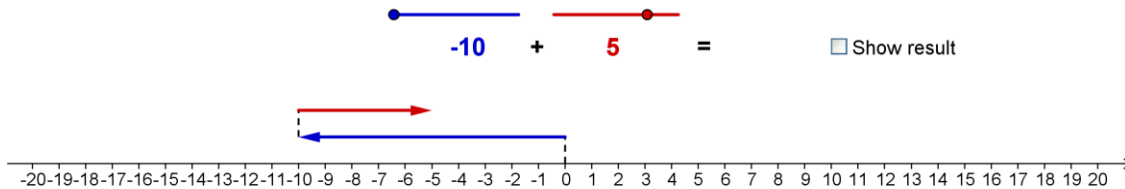
Insert a checkbox into the *Graphics View* that allows you to show or hide the result of the addition problem.



1		Activate tool <i>Check Box</i> .
2		Click on the <i>Graphics View</i> next to the result of the addition problem to open the checkbox dialog window.
3		Enter <code>Show result</code> into the <i>Caption</i> text field.
4		From the drop down menu select <i>text5</i> . The visibility of this object will be controlled by the checkbox. <u>Hint:</u> You can also click on <i>text5</i> in the <i>Graphics View</i> to insert it into the list of objects influenced by the checkbox.
5		Click <i>Apply</i> to create the checkbox.
6		In <i>Move</i> mode check and uncheck the checkbox to try out if <i>text5</i> can be hidden / shown.
7		Fix the checkbox so it can't be moved accidentally any more (<i>Properties dialog</i>).
8		Export this new interactive figure as a dynamic worksheet. <u>Hint:</u> You might want to use a different name for this worksheet.



Boolean variables

A *Check Box* is the graphical representation of a Boolean variable in GeoGebra. It can either be true or false which can be set by checking (Boolean variable = true) or unchecking (Boolean variable = false) the checkbox.

1. Open the *Properties dialog*. The list of *Boolean values* only contains one object called *c*, which is represented graphically as your checkbox.
2. Select *text5* from the list of objects on the left side of the *Object Properties dialog*.
3. Click on tab *Advanced* and look at the text field called *Condition to Show Object*. It shows the name of your checkbox *c*.
Hint: This means that the visibility of *text5* depends on the status of the checkbox.
4. Select point *R* from the list of objects in the *Properties dialog*. Click on tab *Advanced*. The text field *Condition to Show Object* is empty.
5. Enter *j* into the text field *Condition to Show Object*. The visibility of point *R* is now connected to the checkbox as well.
6. Repeat steps 4 and 5 for segment *i* which connects the second vector with point *R* on the number line.

Hint: Now the checkbox controls three objects of your dynamic figure: *text5* (which shows the result of the addition), point *R* and segment *i* (which show the result on the number line).



4. The Sierpinski Triangle









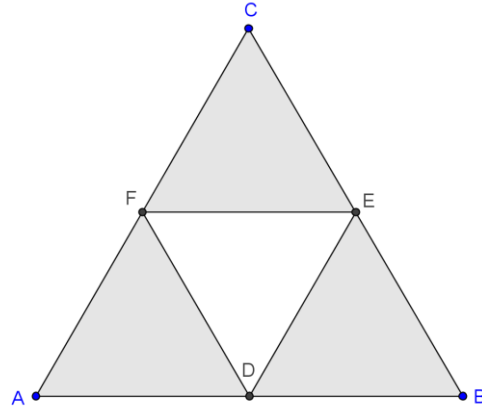

You will now learn how to create a custom tool that facilitates the construction of a so called Sierpinski triangle.

Preparations

- Open a new GeoGebra window.
- Switch to *Perspectives* –  *Geometry*.
- In the *Options* menu set the *Labeling* to *New Points Only*.



Construction Steps

1		Create an arbitrary triangle ABC .
2		Change the color of the triangle to black (<i>Stylebar</i>).
3		Create midpoint D of triangle side AB .
4		Create midpoint E of triangle side BC .
5		Create midpoint F of triangle side AC .
6		Construct a triangle DEF .
7		Change the color of triangle DEF to white and increase the filling to 100% (<i>Properties dialog</i>).
8		Change the color of the sides of triangle DEF to black (<i>Properties dialog</i>).
9		Create a new tool called <i>Sierpinski</i> (menu <i>Tools</i>). <u>Output objects</u> : points D , E and F , triangle DEF , sides of triangle DEF <u>Input objects</u> : points A , B and C <u>Name</u> : <i>Sierpinski</i> <u>Toolbar help</u> : Click on three points
10		Apply your custom tool to the three black triangles ADF , DBE and FEC to create the second stage of the Sierpinski triangle.
11		Apply your custom tool to the nine black triangles to create the third stage of the Sierpinski triangle.



Conditional Visibility

Insert checkboxes that allow you to show and hide the different stages of the Sierpinski triangle.

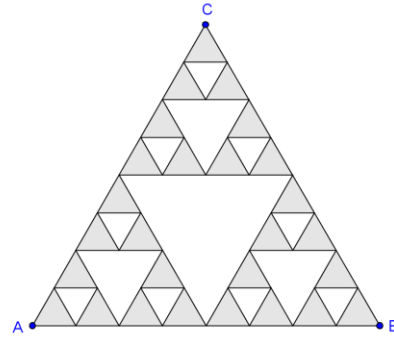

1		Hide all points except from <i>A</i> , <i>B</i> and <i>C</i> .
2		Create a <i>Check Box</i> that shows / hides the first stage of the Sierpinski triangle. <u>Caption:</u> Stage 1 <u>Selected objects:</u> Only the large white triangle and its sides.
3		In <i>Move</i> mode check and uncheck the checkbox to try out if the white triangle and its sides can be hidden / shown.
4		Create a <i>Check Box</i> that shows / hides the second stage of the Sierpinski triangle. <u>Caption:</u> Stage 2 <u>Selected objects:</u> Three medium sized white triangles and their sides.
5		In <i>Move</i> mode check and uncheck the checkbox to try out if the second stage of the Sierpinski triangle can be hidden / shown.
6		Create a <i>Check Box</i> that shows / hides the third stage of the Sierpinski triangle. <u>Caption:</u> Stage 3 <u>Selected objects:</u> Nine small white triangles and their sides.
7		In <i>Move</i> mode check and uncheck the checkbox to try out if the third stage of the Sierpinski triangle can be hidden / shown.

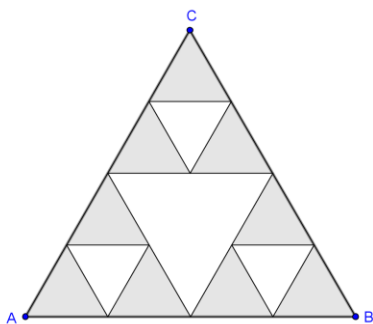

- Stage 1
- Stage 2
- Stage 3

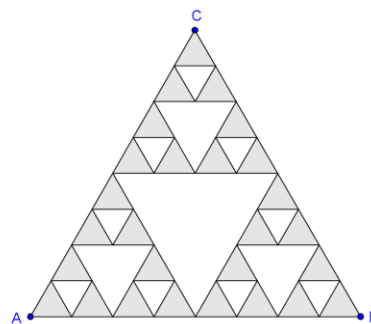

- Stage 1
- Stage 2
- Stage 3



5. Introducing Sequences

GeoGebra offers the command *Sequence* which produces a list of objects. Thereby, the type of object, the length of the sequence (that's the number of objects created) and the step width (e.g. distance between the objects) can be set using the following command syntax:

```
Sequence[<Expression>, <Variable>, <Start Value>,
        <End Value>, <Increment>]
```

Explanations:

- **<Expression>:**
Determines the type of objects created. The expression needs to contain a variable (e.g. $(i, 0)$ with variable i).
- **<Variable>:**
Tells GeoGebra the name of the variable used.
- **<Start Value>, <End Value>:**
Determine the interval for the variable used (e.g. from 1 to 10).
- **<Increment>:**
Is optional and determines the step width for the variable used (e.g. 0.5).

Examples for sequences

- `Sequence[(n, 0), n, 0, 10]`
 - Creates a list of 11 points along the x-axis.
 - Points have coordinates $(0, 0), (1, 0), (2, 0), \dots, (10, 0)$.

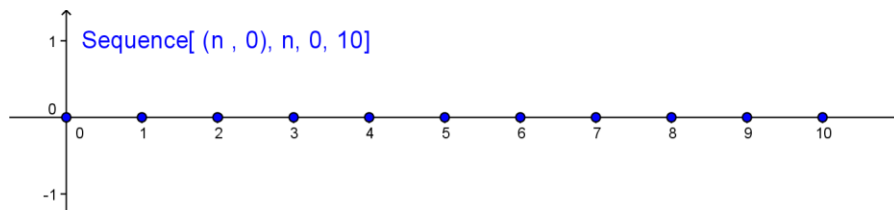

- `Sequence[Segment[(a, 0), (0, a)], a, 1, 10, 0.5]`
 - Creates a list of segments with distance 0.5.
 - Each segment connects a point on the x-axis with a point on the y-axis (e.g. points $(1, 0)$ and $(0, 1)$; points $(2, 0)$ and $(0, 2)$).
- If s is a slider with interval from 1 to 10 and increment 1, then command `Sequence[(i, i), i, 0, s]`
 - creates a list of $s + 1$ points whose length can be changed dynamically by dragging slider s .
 - Points have coordinates $(0, 0), (1, 1), \dots, (10, 10)$

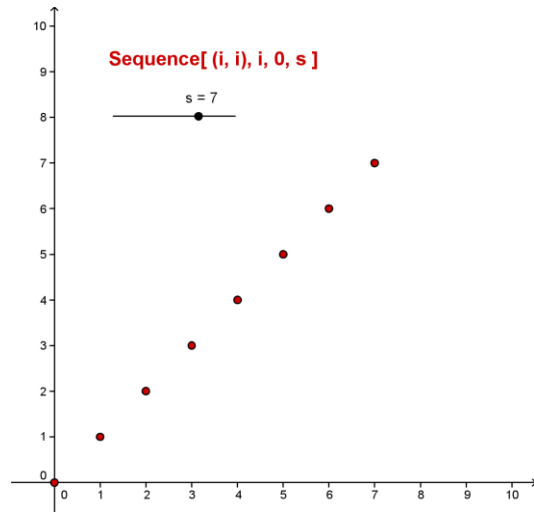
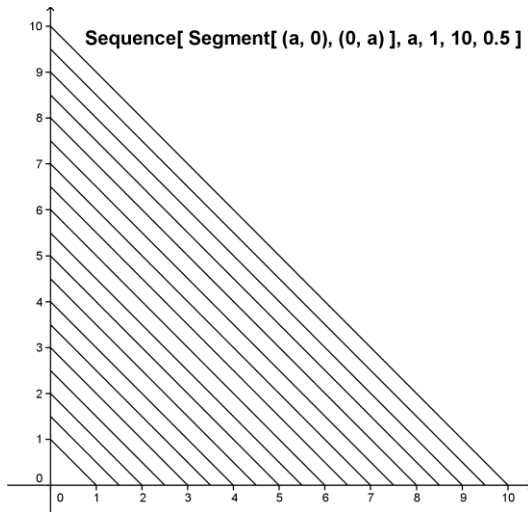

6. Visualizing Multiplication of Natural Numbers



Preparations

- Open a new GeoGebra window.
- Switch to *Perspectives* – *Geometry*.
- Show the *Input Bar* (*View* menu).
- In the *Options* menu set the *Labeling* to *All New Objects*.

$$9 \cdot 7 = 63$$

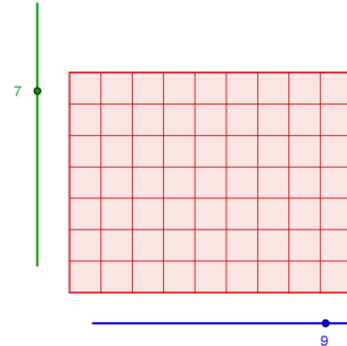

Construction Steps

1		Create a horizontal slider <i>Columns</i> for number with <i>Interval</i> from 1 to 10, <i>Increment</i> 1 and <i>Width</i> 300.
2		Create a new point <i>A</i> .
3		Construct segment <i>a</i> with given length <i>Columns</i> from point <i>A</i> .
4		Move slider <i>Columns</i> to check the segment with given length.
5		Construct a perpendicular line <i>b</i> to segment <i>a</i> through point <i>A</i> .
6		Construct a perpendicular line <i>c</i> to segment <i>a</i> through point <i>B</i> .
7		Create a vertical slider <i>Rows</i> for number with <i>Interval</i> from 1 to 10, <i>Increment</i> 1 and <i>Width</i> 300.



8		Create a circle d with center A and given radius $Rows$.
9		Move slider $Rows$ to check the circle with given radius.
10		Intersect circle d with line b to get intersection point C .
11		Create a parallel line e to segment a through intersection point C .
12		Intersect lines c and e to get intersection point D .
13		Construct a polygon $ABDC$.
14		Hide all lines, circle d and segment a .
15		Hide labels of segments (<i>Stylebar</i>).
16		Set both sliders $Columns$ and $Rows$ to value 10.
17		<p>Create a list of vertical segments.</p> <pre>Sequence[Segment[A+i*(1, 0), C+i*(1, 0)],i,1,Columns]</pre> <p>Note: $A + i*(1, 0)$ specifies a series of points starting at point A with distance 1 from each other. $C + i*(1, 0)$ specifies a series of points starting at point C with distance 1 from each other. $Segment[A + i*(1, 0), C + i*(1, 0)]$ creates a list of segments between pairs of these points. Note, that the endpoints of the segments are not shown in the <i>Graphics View</i>. Slider $Column$ determines the number of segments created.</p>
18		<p>Create a list of horizontal segments.</p> <pre>Sequence[Segment[A+i*(0, 1), B+i*(0, 1)], i, 1, Rows]</pre>
19		Move sliders $Columns$ and $Rows$ to check the construction.
20	ABC	<p>Insert static and dynamic text that state the multiplication problem using the values of sliders $Columns$ and $Rows$ as the factors:</p> <pre>text1: Columns text2: * text3: Rows text4: =</pre>
21		<p>Calculate the <i>result</i> of the multiplication:</p> <pre>result = Columns * Rows</pre>
22	ABC	Insert dynamic $text5$: <code>result</code>
23		Hide points A , B , C and D .
24		Enhance your construction using the <i>Stylebar</i> .



7. Challenge of the Day: String Art Based on Bézier Curves





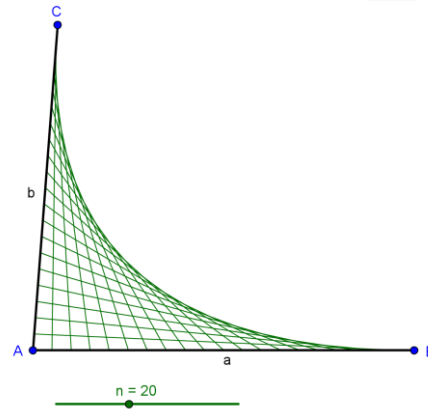



Bézier curves are parametric curves used in computer graphics. For example, they are used in order to create smooth lines of vector fonts. Let's create some 'string art' based on Bézier curves.



Preparations

- Open a new GeoGebra window.
- Switch to *Perspectives* –  *Geometry*.
- Show the *Input Bar* (*View* menu).
- In the *Options* menu set the *Labeling* to *All New Objects*.

Construction Steps

1		Create segment a with endpoints A and B .
2		Create segment b with endpoints A and C .
3		Create a slider for number n with <i>Interval</i> 1 to 50, <i>Increment</i> 1 and <i>Width</i> 200.
4		Create <code>Sequence[A + i/n (B - A), i, 1, n]</code> . <u>Hint</u> : This sequence creates a list of n points along segment AB with a distance of one n^{th} of the length of segment a .
5		Create <code>Sequence[A + i/n (C - A), i, 1, n]</code> . <u>Hint</u> : This sequence creates a list of n points along segment AC with a distance of one n^{th} of the length of segment b .
6		Hide both lists of points.
7		Create a list of segments. <code>Sequence[Segment[Element[list1, i], Element[list2, n+1-i]], i, 1, n]</code> <u>Hint</u> : These segments connect the first and last, second and last but one, last and first point of <i>list1</i> and <i>list2</i> .
8		Enhance your construction using the <i>Stylebar</i> .
9		Move points A , B and C to change the shape of your Bézier curve.
10		Drag slider n to change the number of segments that create the Bézier curve.

Note: The segments you just created are tangents to a quadratic Bézier curve.



Task

Create more 'string art' with GeoGebra using sequences of points and segments.

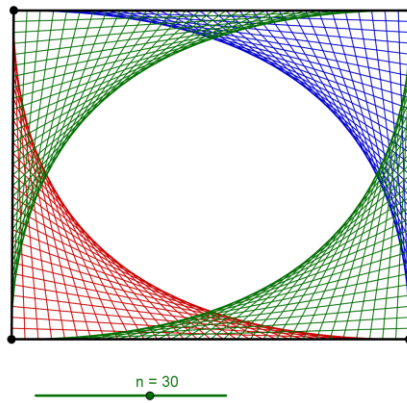

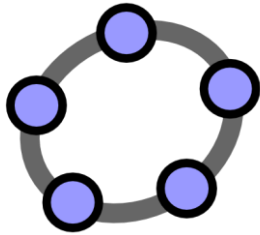



Spreadsheet View and Basic Statistics Concepts

GeoGebra Workshop Handout 9



1. Introduction to GeoGebra's Spreadsheet View

You can open the *Spreadsheet View* by either choosing  *Spreadsheet & Graphics* from the Perspectives sidebar or by selecting  *Spreadsheet* from the *View* menu.

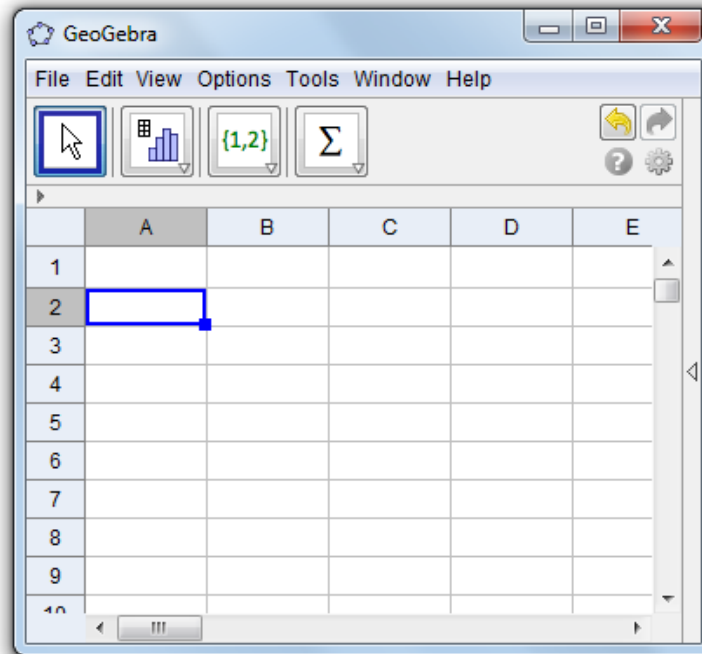

Spreadsheet Cells Input

In GeoGebra's *Spreadsheet View* every cell has a **specific name** that allows you to directly address each cell. For example, the cell in column A and row 1 is named *A1*.

Note: These cell names can be used in expressions and commands in order to address the content of the corresponding cell.

Into the spreadsheet cells you can **enter** not only numbers, but **all types of mathematical objects** that are supported by GeoGebra (e.g. coordinates of points, functions, commands). If possible, GeoGebra immediately displays the graphical representation of the object you enter into a spreadsheet cell in the *Graphics View* as well. Thereby, the name of the object matches the name of the spreadsheet cell used to initially create it (e.g. *A5*, *C1*).

Note: By default, spreadsheet objects are classified as auxiliary objects in the *Algebra View*. Choose  *Auxiliary Objects* from the *Algebra View's Stylebar* to show these objects.



2. Record to Spreadsheet Feature

Preparations

- Open a new GeoGebra window.
- Switch to *Perspectives* –  *Spreadsheet & Graphics*.
- Show the *Input Bar* (*View* menu).

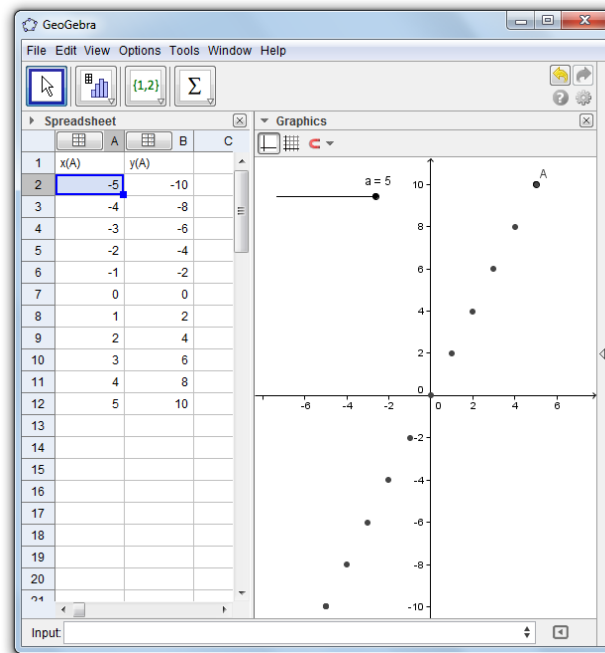







Introduction of new feature



Construction Steps

1		Create a slider a with default <i>Interval</i> and <i>Increment</i> 1.
2	$A = (a, 2a)$	Create point A by entering $A = (a, 2a)$ into the <i>Input Bar</i> . <u>Hint:</u> The value of slider a determines the x -coordinate of point A while the y -coordinate is a multiple of this value.
3	AA	Show the label of point A in the <i>Graphics View</i> .



4		Change the value of slider a to examine different positions of point A .
5		Use tools <i>Move Graphics View</i> , as well as <i>Zoom In</i> and <i>Zoom Out</i> to adjust the visible part of the <i>Graphics View</i> and make point A visible in all positions.
6		Turn on the trace of point A . <u>Hint:</u> Right-click (MacOS: <i>Ctrl</i> -click) on point A and select <i>Trace On</i> from the appearing context menu.
7		Change the value of slider a to examine the trace point A leaves for every slider position.
8		Set the value of slider a to -5 .
9		Record the coordinates for different positions of point A to the spreadsheet: (1) Right-click (MacOS: <i>Ctrl</i> -click) on point A and select <i>Record to Spreadsheet</i> from the appearing context menu. Choose <i>Values of $x(A)$, $y(A)$</i> , then close the <i>Record to Spreadsheet</i> dialog. (2) Now, change the value of slider a in order to record the coordinates of all other possible positions of point A to the spreadsheet as well. Note: Do not switch to another tool before moving the slider.

Tasks

Task 1: Examine the pattern of y -values in column B

You could give this construction to your students and let them explore the pattern in column B , which is created by the y -coordinates of different positions of point A . Encourage your students to make a prediction about a function graph that runs through all different positions of point A . Have your students enter the corresponding function into the *Input Bar* in order to check if their prediction was correct (e.g. students enter $f(x) = 2x$ to create a line through all points).

Task 2: Create a new problem

Change the y -coordinate of point A in order to create a new problem:

- Double-click on point A in  *Move* mode to open the *Redefine* dialog.

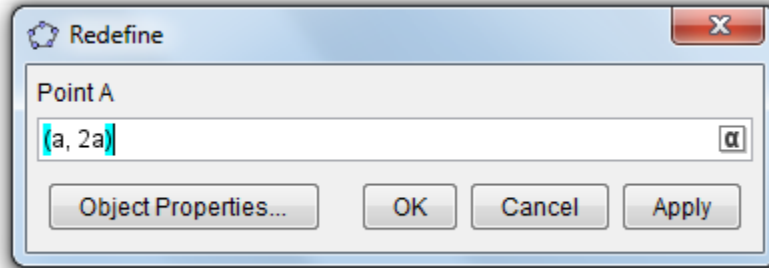

- Change the y -coordinate of point A to, for example, a^2 .
 - Use the *Stylebar* to change the color or size of point A .
 - Repeat steps 7 to 9 of the instructions above in order to record the coordinates of the new positions of point A to the spreadsheet.
- Note:** If you didn't delete the old values in columns A and B , GeoGebra automatically uses the next two empty columns (e.g. columns C and D) in order to record the new values for x -coordinates and y -coordinates.



3. Relative Copy and Linear Equations

Preparations

- Open a new GeoGebra window.
- Switch to *Perspectives* –  *Spreadsheet & Graphics*.
- Show the *Input Bar* (*View* menu).

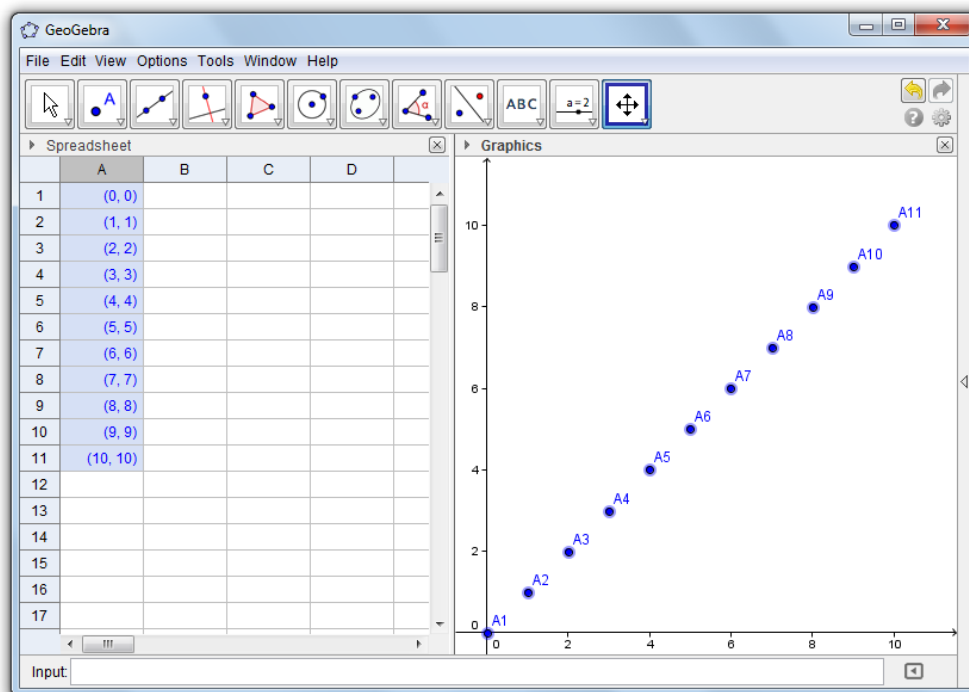



Construction Steps

1		Activate tool <i>Move Graphics View</i> and drag the origin of the coordinate system close to the lower left corner of the <i>Graphics View</i> .
2	(0, 0)	In the <i>Spreadsheet View</i> , click on cell <i>A1</i> enter the point coordinates (0, 0).
3	(1, 1)	In the <i>Spreadsheet View</i> , click on cell <i>A2</i> enter the point coordinates (1, 1).
4	AA	Show the labels of both points in the <i>Graphics View</i> .
5		Relative copy the inserted point coordinates to other cells in column A: (1) Highlight both cells <i>A1</i> and <i>A2</i> by using the mouse. (2) Click on the little square at the lower right corner of the highlighted cell range. (3) Hold the mouse button down and drag the pointer down to cell <i>A11</i> .
6	 	Use tools <i>Move Graphics View</i> , as well as <i>Zoom In</i> and <i>Zoom Out</i> to adjust the visible part of the <i>Graphics View</i> and make all points visible.

Tasks

Task 1: Examine the coordinates of the point sequence

What sequence of numbers is created if you apply the 'relative copy' feature of the *Spreadsheet View* the way it is described above?

Hint: Examine the *x*-coordinates of all created points and come up with a conjecture about how they are related. Then, check your conjecture using the *y*-coordinates of the points.

Task 2: Find the matching equation

Make a prediction about an equation that would create a graph going through all points of this sequence. Enter this equation into the *Input Bar* in order to check your prediction.

Task 3: Create a new problem

Change the coordinates of the initial points in order to create a sequence of points that can be examined by your students.



Version 1: Change the initial points in the *Spreadsheet View*



Double-click in cell *A2* and change the coordinates of the corresponding point to $(1, 2)$. After hitting the *Enter*-key, all points that depend on point *A2* automatically adapt to this change, both in the *Spreadsheet View* as well as in the *Graphics View*.

Version 2: Change the initial points in the *Graphics View*

Activate tool  *Move* and drag point *A2* to a different position in the coordinate system. Immediately, all dependent points dynamically adapt to these changes both in the *Graphics View* as well as in the *Spreadsheet View*.

Note: In order to restrict the coordinates of the points to be integers, you can change the  *Point Capturing* to *Fixed on Grid*. Show the  *Grid* using the *Stylebar*.

Hint: By changing the coordinates of point *A1* as well you are able to create problems that result in linear equations of the form $y = m x + b$ which do not run through the origin of the coordinate system.

4. Investigating Number Patterns



Let's investigate how the surface of a cube changes depending on the length of its edges.

Preparations with Paper and Pencil

Calculate the surface of a cube for the given length e of its edges. Pick at least two edge lengths from each table but do not pick the same numbers as your neighbor.

Edge	Surface	Edge	Surface
1		6	
2		7	
3		8	
4		9	
5		10	

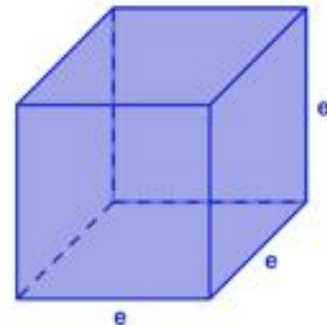



Preparations in GeoGebra

- Open a new GeoGebra window.
- Switch to *Perspectives* – *Spreadsheet & Graphics*.
- Show the *Input Bar* (*View* menu).
- In the *Options* menu set the *Labeling* to *New Points Only*.

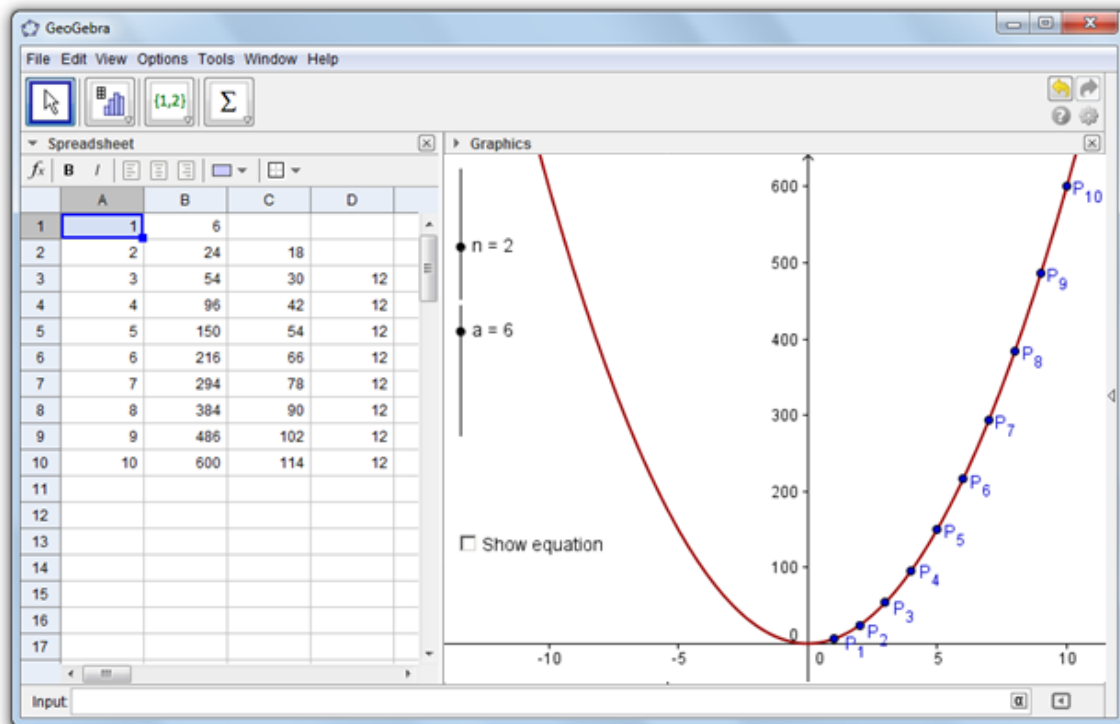

Construction Steps

Create a Scatter Plot from your Data

1	Enter the following numbers into the spreadsheet cells of column A: A1: 1 A2: 2
2	Highlight cells A1 and A2. Relative copy the values to cell A10 in order to create a sequence of different edge lengths. <u>Hint</u> : This creates the integers from 1 to 10.
3	In cell B1, enter the surface formula with reference to the edge length of the cube in cell A1. <u>Hint</u> : After entering the equal sign, you can click on cell A1 to enter its name into the active cell B1.



4	Select cell $B1$ and relative copy the formula down to cell $B10$.
5	<p>Create a Scatter Plot from this data:</p> <ol style="list-style-type: none"> (1) Use the mouse to highlight all cells of columns A and B that contain numbers. (2) Right-click (MacOS: <i>Ctrl</i>-click) on one of the highlighted cells and select <i>Create List of Points</i> from the appearing context menu. <p><u>Note</u>: The values in column A determine the x-coordinates and the values in column B specify the y-coordinates of the plotted points.</p> <p><u>Hint</u>: The points created from the data are displayed in the <i>Algebra View</i> as a list of points. By default, GeoGebra calls this list L_1.</p>
6	<p> Use tool <i>Move Graphics View</i> in order to change the scale of the y-axis so that all points are visible in the <i>Graphics View</i>.</p> <p><u>Hint</u>: Select tool <i>Move Graphics View</i>. Click on the y-axis and drag it down until you can see the 600 tick mark.</p>

Investigate the Number Pattern in Column B

7	In cell $C2$, enter the formula $=B2-B1$ to compute the difference of the two successive surface values.
8	Select cell $C2$ and relative copy the formula down to cell $C10$.
9	In cell $D3$, enter the formula $=C3-C2$ to compute the difference of the two successive differences.
10	Select cell $D3$ and relative copy the formula down to cell $D10$.



Task 1

Examine the number sequences in columns C and D . Make a conjecture about the polynomial function that runs through all points plotted in the *Graphics View* and allows you to compute the surface of a cube for any given edge length e .





- Is it possible to determine the degree of this polynomial by investigating the sequences of differences you generated in columns C and D ?
- Explain to your neighbor why we were repeatedly calculating differences of successive values and what they actually mean.
- Is it possible to determine the coefficient of the polynomial by investigating the sequences of differences you generated in columns C and D ?
- Would this also work if the values in column A are not successive integers (e.g. 1, 3, 5,...)? Give a reason for your answer.



Check your Conjecture about the Polynomial

11		Create a slider n with <i>Interval</i> from 0 to 5 and <i>Increment</i> 1. Change the orientation of the slider from <i>Horizontal</i> to <i>Vertical</i> (Tab <i>Slider</i>).
12		Create a slider a with <i>Interval</i> from 0 to 10 and <i>Increment</i> 1. Change the orientation of the slider from <i>Horizontal</i> to <i>Vertical</i> (Tab <i>Slider</i>).
13		Enter the polynomial $f(x) = a * x^n$ in order to create a polynomial of degree n with coefficient a . <u>Note:</u> Both the degree n as well as the coefficient a can be changed by using the corresponding sliders.
14		Change the values of sliders a and n to match your conjecture. Does the polynomial run through all points plotted in the <i>Graphics View</i> ?

Enhance your Construction

15		Insert the polynomial's equation as a dynamic text in the <i>Graphics view</i> . <u>Hint:</u> Select tool <i>Text</i> and click on the <i>Graphics View</i> to open the text edit dialog window. <ol style="list-style-type: none"> (1) Enter $f(x) =$ into the text edit dialog window. (2) Click on the graph of the polynomial to insert its name into the text edit dialog window. <u>Note:</u> GeoGebra will enter the syntax necessary for dynamic text automatically. <ol style="list-style-type: none"> (3) Click on the <i>OK</i> button.
16		Insert a checkbox that allows you to show/hide the polynomial's equation. <u>Hint:</u> Select tool <i>Check Box</i> and click on the <i>Graphics View</i> to open the checkbox dialog window. <ol style="list-style-type: none"> (1) Enter the caption <i>Show equation</i>. (2) Click on the little arrow to open list of available objects. (3) Select <i>text1</i> from this list and click the <i>Apply</i> button.
17		Activate the <i>Move</i> tool and try out if your checkbox controls the visibility of the text.
18		Open the <i>Properties dialog</i> and enhance the layout of the objects in the <i>Graphics View</i> (e.g. change the color of the polynomial and points, match the color of the text with the color of the polynomial, fix the position of the slider, checkbox and text in the <i>Graphics View</i>).



Task 2

- Try if this concept of investigating sequences of differences of two successive function values works for all polynomials $f(x) = a x^n$.
Hint: You can enter a formula into cell *B1* and relative copy it down to cell *B10* in order to create a list of function values. Don't forget to start the formula with an equal sign (e.g. $= x^2$).
- What modifications in the *Spreadsheet View* and *Graphics view* are necessary to be able to easily determine the constant of polynomials $f(x) = a x^n + b$?

5. Scatter Plot and Best Fit Line



Preparations

- Open a new GeoGebra window.
- Switch to *Perspectives* – *Spreadsheet & Graphics*.
- Show the *Input Bar* (*View* menu).
- In the *Options* menu set the *Labeling* to *New Points Only*.

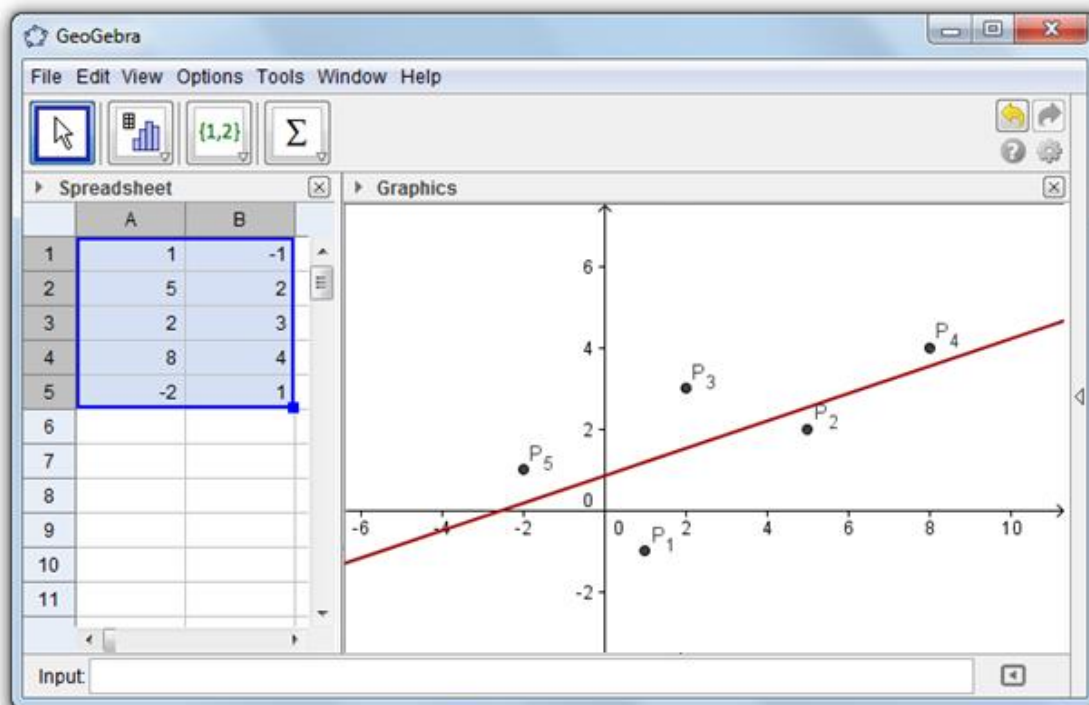





Introduction of new tool



Construction Steps

1	Enter the following numbers into the spreadsheet cells of column A: A1: 1 A2: 5 A3: 2 A4: 8 A5: -2
2	Enter the following numbers into the spreadsheet cells of column B: B1: -1 B2: 2 B3: 3 B4: 4 B5: 1
3	<p>Create a Scatter Plot from this data:</p> <ol style="list-style-type: none"> (1) Use the mouse to highlight all cells of columns A and B that contain numbers. (2) Right-click (MacOS: <i>Ctrl</i>-click) on one of the highlighted cells and select <i>Create List of Points</i> from the appearing context menu. <p><u>Note:</u> The values in column A determine the <i>x</i>-coordinates and the values in column B specify the <i>y</i>-coordinates of the plotted points.</p>
4	 <p>Use tool <i>Best Fit Line</i> in order to create the line that best fits your data points.</p> <p><u>Hint:</u> Activate tool <i>Best Fit Line</i> and select all data points using a selection rectangle: Click in the upper left corner of the <i>Graphics View</i>. Hold the mouse key down while moving the pointer to the lower right corner of the <i>Graphics View</i> in order to specify the selection rectangle.</p>
5	Change color and thickness of the line using the <i>Stylebar</i> .
6	 <p>Using this construction you can easily demonstrate how outliers impact the best fit line of a data set:</p> <p>Drag one of the points with the mouse and explore how this modification influences the best fit line.</p> <p><u>Hint:</u> You can also change the initial data in the <i>Spreadsheet View</i>.</p>

Importing Data from other Spreadsheets

Note: GeoGebra allows you to copy and paste data from other spreadsheet software into the GeoGebra spreadsheet:

- Select and copy the data you want to import (e.g. use the keyboard shortcut *Ctrl-C* (MacOS: *Cmd-C*) in order to copy the data to your computer's clipboard).



- Open a GeoGebra window and show the *Spreadsheet View*.
- Click on the spreadsheet cell that should contain the first data value.
- Paste the data from your computer's clipboard into GeoGebra's *Spreadsheet View* (e.g. use the shortcut *Ctrl-V* (MacOS: *Cmd-V*) or right-click (MacOS: *Ctrl-click*) on the highlighted cell and select  *Paste*).

6. Challenge of the Day: Explore Basic Statistics Commands

Yesterday, you gave a mathematics quiz to the 25 students of your 1st period math class. After the quiz, you asked your students to rate the difficulty of the quiz on a scale from 1 ('very easy') to 5 ('very difficult').

- 4 of your students rated the quiz 'very easy' (1)
- 6 students rated the quiz 'easy' (2)
- 6 other students rated the quiz 'difficult' (4)
- 1 student rated the quiz 'very difficult' (5)
- The rest of the students thought the difficulty of the quiz was 'ok' (3).

Task 1: Create a histogram

Enter the data into GeoGebra's *Spreadsheet View* and create a histogram that visualizes this data.

Hints:

- If you don't know how to use command *Histogram*, enter the command into the *Input Bar* and press the *F1* key.
Note: *Class boundaries* determine the position and width of the bars of the histogram. The absolute number of students that rated the difficulty of the quiz for each item determines the height of the histogram bars.
- Choose the class boundaries so that the actual rating score is displayed in the middle of each histogram bar.
- You need to create a list of the data in each column before you can use the *Histogram* command
Note: Highlight all numbers in one column and right-click (MacOS: *Ctrl-click*) on one of the highlighted cells. Select *Create List* from the appearing context menu.

Task 2: Determine mean, median and mode

1. Make a prediction for mean, median and mode of the data you collected.
Hint: You can use command *Sort* in order to sort the list of frequencies of students who rated the difficulty of the quiz in each category.
2. Check your prediction using the commands *Mean*, *Median* and *Mode*.



Algebra | Spreadsheet | Graphics

List
 Mode = {3}
 list1 = {0.5, 1.5, 2.5, 3.5, 4.5, 5.5}
 list2 = {4, 6, 8, 6, 1}
 list3 = {1, 1, 1, 1, 2, 2, 2, 2, 2, 2, 3, 3, ...}

Number
 Mean = 2.76
 Median = 3
 a = 25

	A	B
1	0.5	
2	1.5	4
3	2.5	6
4	3.5	8
5	4.5	6
6	5.5	1
7		
8		
9		
10		
11		
12		
13		
14		
15		
16		
17		
18		
19		

Input:

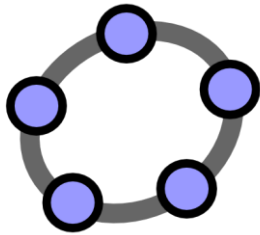



CAS View – Computer Algebra System & CAS Specific Commands

GeoGebra Workshop Handout 10



1. Introduction to GeoGebra's CAS View

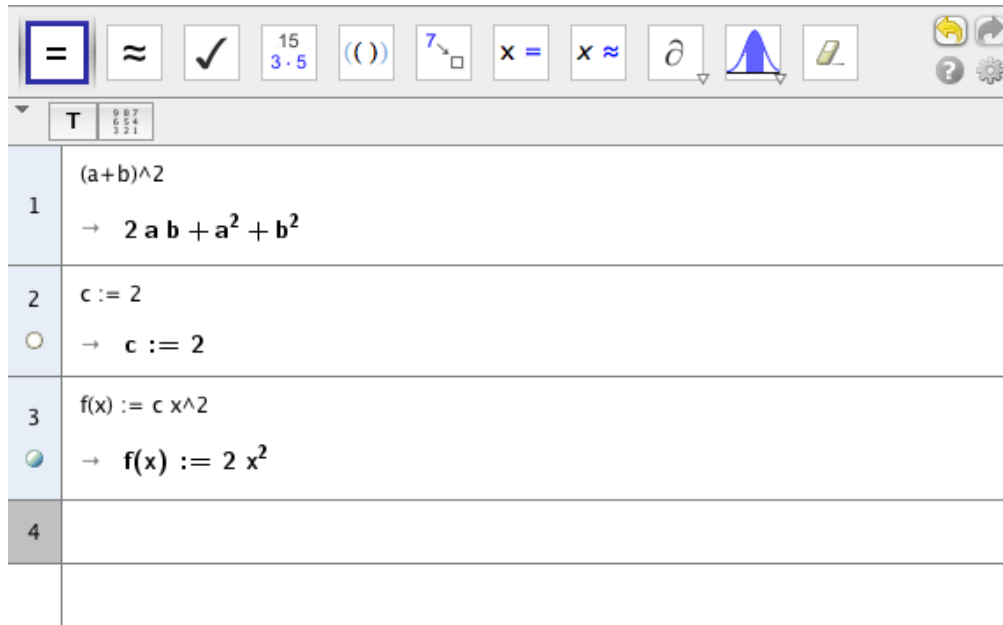

The *CAS View* allows you to use GeoGebra's CAS (Computer Algebra System) for symbolic computations. The view consists of rows, each of them has an input field at the top and an output display at the bottom.

You can open the *CAS View* by either choosing  CAS & Graphics from the Perspective Sidebar or by selecting  CAS from the View menu.



Input in CAS View

In the GeoGebra's CAS View use the equal sign to enter an equation. The CAS toolbar offers three different tools to evaluate your input with:

-  "Evaluate" calculates and simplifies the input in a symbolic way,
-  "Numeric" calculates the input numerically and yields the result in decimal notation and
-  "Keep Input" keeps and checks the input.

"Keep Input" is very useful if you don't want your input to be simplified automatically, for example introducing the manipulation of expressions. Further more, by selecting a part of your input, you can apply a tool to this part only.

You can use the input fields the same way you would use the *Input Bar*, with following differences:



- You can use variables that were not assigned any value. For example $(a + b)^2$ evaluates to $a^2 + 2ab + b^2$ if a and b are free variables.
- “=” is used for equations and “:=” for assignments. Therefore $c = 2$ is an equation and $c := 2$ assigns the value 2 to c .

Several tools from GeoGebra’s CAS View

$=$	Evaluate	New!	\rightarrow \square	Substitute	New!
\approx	Numeric	New!	$\times =$	Solve	New!
\checkmark	Keep Input	New!	$\times \approx$	Solve Numerically	New!
$\frac{15}{3 \cdot 5}$	Factor	New!	∂	Derivative	New!
$(())$	Expand	New!	\int	Integral	New!

Basic Input

- *Enter*: Evaluate the input symbolically, e.g. $\frac{3}{4} a - \frac{1}{4} a$ yields $\frac{1}{2} a$.
- *Ctrl - Enter*: Evaluate the input numerically, e.g. $\frac{3}{4}$ yields 0.75 .
- *Alt - Enter*: Check the input but do not evaluate, e.g. $b + b$ remains $b + b$. Note that assignments work regardless of the tool chosen, in explicit: *Keep Input* does assign the right hand side to the label, variable or function name provided, though not evaluating the assigned input.
- In an empty row type:
 - Space bar for previous output
 -) for previous output in parentheses
 - = for previous input
- Suppress output with a semicolon at the end of your input, e.g. $a := 5;$

You can refer other rows in the CAS View in two ways:

- Static row references copy the output and **won't** be updated if the *referenced* row is subsequently changed
 - # copies the previous output
 - #5 copies the output of row 5
- Dynamic row references insert a reference to another row instead of the actual output and therefore **will** be updated if the *referenced* row is subsequently changed
 - \$ inserts a reference to the previous output
 - \$5 inserts a reference to the output of row 5



2. Manipulating Equations

Manipulating terms and equations are important topics in lower grade secondary school. In this example you will learn how to achieve this in the *CAS View*.

Preparations

- Open a new GeoGebra window.
- Switch to *Perspectives* – *CAS & Graphics*.

Introduction of New Tools

$=$	Evaluate	New!
\approx	Numeric	New!
✓	Keep Input	New!

Construction Steps

Finishing your construction, the *CAS View* will look like this:

	T
1	$(2x - 1) / 2 = 2x + 3$ <input checked="" type="radio"/> $\frac{2x - 1}{2} = 2x + 3$
2	$((2x - 1) / 2 = 2x + 3) + 1/2$ <input checked="" type="radio"/> $\left(\frac{2x - 1}{2} = 2x + 3\right) + \frac{1}{2}$
3	$((2x - 1) / 2 = 2x + 3) + 1 / 2$ <input type="radio"/> $\rightarrow x = 2x + \frac{7}{2}$
4	$((2x - 1) / 2 = 2x + 3) + 1 / 2$ <input type="radio"/> $\approx x = 2x + 3.5$



1	✓	Enter the equation $(2x - 1) / 2 = 2x + 3$ into the first row. Use the <i>Keep Input</i> tool to prevent automatic simplification.
2	✓	Type $)$ in the second row to copy the output of the first row and automatically put parentheses around it. Then type $+ 1/2$ to add one half to both sides of the equation. Again apply the <i>Keep Input</i> tool.
3	=	Press the space key to copy the previous output into the third row. Use the <i>Evaluate</i> tool to calculate the result symbolically, in explicit yielding the rational number as a fraction.
4	≈	Click onto the output of the second row to copy it to the currently selected row four. Applying the <i>Numeric</i> tool computes the result numerically, the rational number is given in decimal notation.

Hint: There are further ways of solving equations in the *CAS View*, for example using the commands *Solve* and *NSolve* or their respective tools. Please find more information in the manual: <http://help.geogebra.org>.

Challenge: Think about the pros and cons of using *CAS View* to solve equations in school.

3. GCD and LCM



In school the greatest common divisor (GCD) and the least common multiple (LCM) of two or more numbers are usually calculated by factoring the numbers involved. The product of all occurring prime factors to certain powers then results in the GCD and the LCM. For each prime factor:

- Choose the minimum of the powers it has in the involved numbers to obtain the GCD.
- Choose the maximum of the powers it has in the involved numbers to obtain the LCM.

Preparations

- Open a new GeoGebra window.
- Switch to *Perspectives* –  *CAS & Graphics*.

Introduction of New Tool

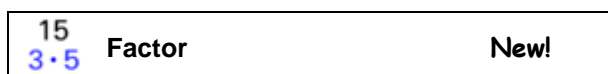



Construction Steps

Finishing your construction, the *CAS View* will look like this:

T	
1	240 Factor: $2^4 \cdot 3 \cdot 5$
2	160 Factor: $2^5 \cdot 5$
3	$2^4 * 5^1$ → 80
4	$2^5 * 3^1 * 5^1$ → 480
5	GCD[240, 160] → 80
6	LCM[240, 160] → 480

1	15 3·5	Choose and enter an arbitrary number, for example 240 and click the <i>Factor</i> tool.
2	15 3·5	Choose and enter another arbitrary number, for example 160. Again apply the <i>Factor</i> tool.
3		Calculate the GCD of both numbers by multiplying the common prime factors to the minimum power occurring in the products: $2^4 * 5^1$ <u>Hint:</u> Use “^” to denote “to the power of”.
4		Calculate the LCM of both numbers by multiplying the prime factors to the maximum power occurring in the products: $2^5 * 3^1 * 5^1$
5		Use the command <i>GCD</i> to compute the greatest common divisor of both numbers automatically: Enter and evaluate GCD[240, 160]
6		Achieve the same for the lowest common multiple by entering and evaluating LCM[240, 160]



Challenge: The *CAS View* can be used to calculate the GCD and LCM of arbitrary polynomials in exactly the same way as with numbers. Go ahead and compute the GCD and LCM of $a x^2 - 2 a b x + a b^2$ and $x^2 - b^2$ in both ways employed above!

Hint: Make sure neither a nor b have been assigned a value previously. Open a new window if you are not sure. The solutions are $x - b$ and $a x^3 - a b x^2 - a b^2 x + a b^3$, respectively.

Back to School ...

- Since factoring of large numbers is not feasible in general, another algorithm is applied frequently: the *Euclidean Algorithm*. Recall or look up how and why it works. Which approach do you prefer?
- Think about the pros and cons calculating GCD and LCM with and without electronic means, like GeoGebra, in school.

4. Intersecting Polynomial Functions



Intersect the parabola $f(x) := (2 x^2 - 3 x + 4) / 2$ with the line $g(x) := x / 2 + 2$

Preparations

- Open a new GeoGebra window.
- Switch to *Perspectives* –  *CAS & Graphics*.

Introduction of New Tool

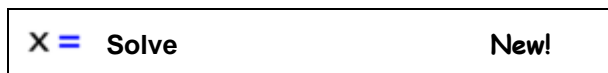



Construction Steps

Finishing your construction, GeoGebra will look like this:

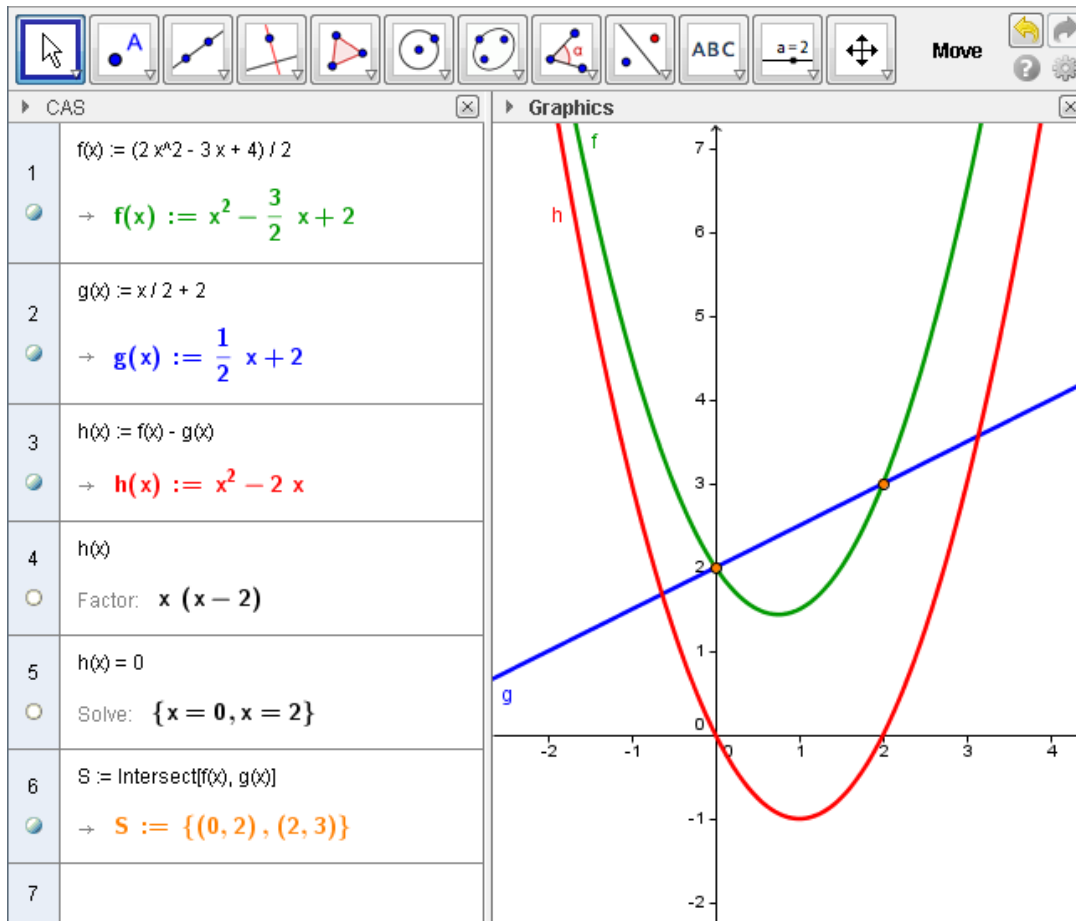

1	Define the function f as $f(x) := (2x^2 - 3x + 4) / 2$ <u>Hint:</u> Use “:=” for definitions and “=” for equations.
2	Define the function g as $g(x) := x / 2 + 2$
3	Define the function h as $h(x) := f(x) - g(x)$
4	15 3·5 Enter $h(x)$ into the fourth row and apply the tool <i>Factor</i> . You can immediately read off the roots of h .
5	x = Enter $h(x) = 0$ and apply the <i>Solve</i> tool to obtain the x-coordinates of the intersection points.
6	Calculate the intersection points by using the command <i>Intersect</i> . $S := \text{Intersect}[f(x), g(x)]$
7	Adjust color, line thickness and style of the objects in the <i>Graphics View</i> .



Hint: Like functions defined via the *Input Bar*, functions defined in the *CAS View* are automatically drawn in the *Graphics View*. Moreover, color changes in any other view affect the *CAS View* as well, thereby emphasizing the connection between the different representations of the same object in different views.

Challenge: Explain why the roots of h correspond to the intersection points of f and g .

Challenge: In the course of the above construction you have already solved the problem of intersecting the two polynomial functions f and g in three different ways. Find another!

Back to School ...

- (a) In general, different formulas can describe the same function. Decide whether this is the case here!
If yes, choose an appropriate tool from the CAS Toolbar and show the equality. If no, give an argument mapping to two different images!
- | | |
|------------------------------|----------------------|
| i. $f_1(x) = (2 - x)(2 + x)$ | $f_2(x) = 4 - x^2$ |
| ii. $g_1(t) = t^2 - 4t + 2$ | $g_2(t) = (t - 2)^2$ |
| iii. $h_1(s) = s - a^2$ | $h_2(a) = a - s^2$ |
- (b) Consider the function $g: \mathbb{R} \rightarrow \mathbb{R}, t \mapsto t^2$.
- i. For which arguments is $g(t) > 0$?
 - ii. $g(-t) = g(t)$ holds for all arguments t . Why?



5. Solving Exponential Equations

Chess & Grains

For many centuries chess has been a game well known and popular. Its very creation is surrounded by different variants of the following legend:

Once upon a time an Indian ruler led his country and citizens into poverty and misery. A wise man intended to call the ruler's attention to his failures, yet feared his wrath. So he devised the game chess: While in chess the king is the most important piece beyond doubt, it is utterly helpless without the other piece. Even pawns play a crucial role.

Getting to know chess the Indian ruler understood the message and became more gentle and gracious. Highly impressed he offered the wise man a reward of his choice. When the wise man asked for one grain for the first square, two for the second, four for the third, and so on, the ruler thought this a modest and humble wish and granted it gladly.

How many grains are there on square number five?
Which square are 1024 grains on?



Preparations

- Open a new GeoGebra window.
- Switch to *Perspectives* –  *CAS & Graphics*.



Introduction of New Tool

 **Solve Numerically** **New!**

Construction Steps

Finishing your construction, the *CAS View* will look like this:

T	
1	$f(n) := 2^n$ → $f(n) := 2^n$
2	$f(5)$ → 32
3	$1024 = f(n)$ Solve: $\{n = 10\}$
4	$1024 = f(n)$ NSolve: $\{n = 10\}$

1	Define the function f as $f(n) := 2^n$. <u>Hint:</u> Use “:=” for definitions and “=” for equations.
2	Calculate the number of grains at the fifth piece as $f(5)$.
3	 Enter $1024 = f(n)$. Now find a n satisfying this equation by applying the <i>Solve</i> tool. <u>Hint:</u> You could also use the <i>Solve</i> command instead: <code>Solve[1024 = f(n)]</code> .
4	 Alternatively, employ the <i>Solve Numerically</i> tool to solve numerically. <u>Hint:</u> You could also use the <i>NSolve</i> command instead: <code>NSolve[1024 = f(n)]</code> .



Hint: Specify the variable to solve for by adding it as second argument, for example `Solve[1024 = f(n), n]` This works both with the *Solve* and the *NSolve* command!

Challenge: Define the function g as $g(t) := c * a^t$ Use the commands *Solve* and *NSolve* to

- find t such that $g(t) = c/a$,
- find c such that $g(2) = 225$ and
- find a such that $g(2) = 255$.



6. Solving Systems of Equations

In this section you learn how to solve systems of equations with just one click, including non-linear equations and derivatives. Let's find a polynomial function of degree three featuring the saddle point $(1,1)$ as well as the point $(2,2)$.

Preparations

- Open a new GeoGebra window.
- Switch to *Perspectives* –  *CAS & Graphics*.

Construction Steps

Finishing your construction, GeoGebra will look like this:

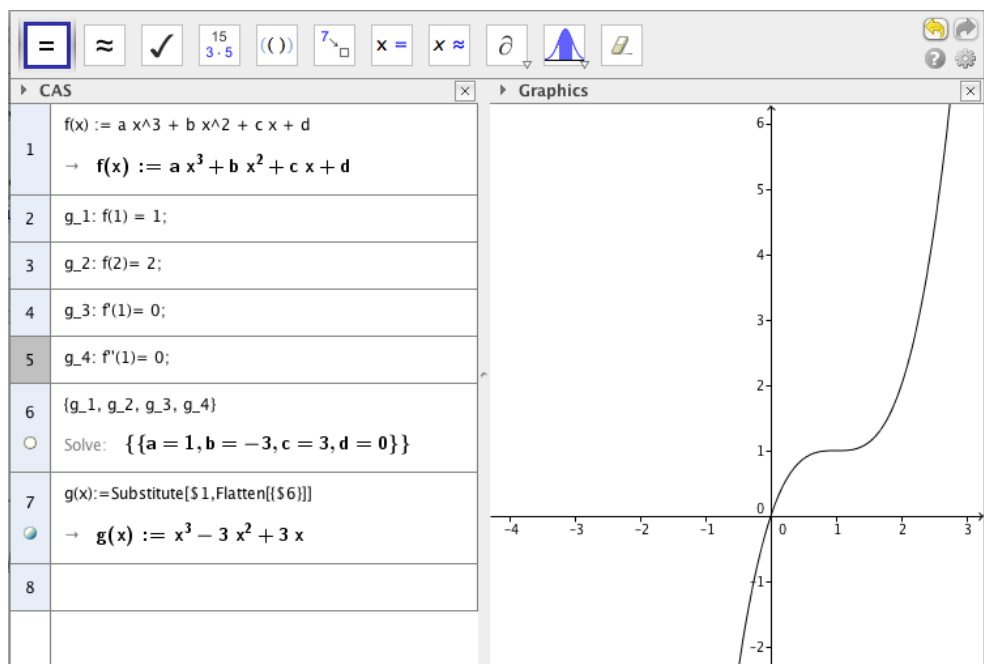

The screenshot shows the GeoGebra interface with the CAS and Graphics views. The CAS view contains the following steps:

- $f(x) := a x^3 + b x^2 + c x + d$
→ $f(x) := a x^3 + b x^2 + c x + d$
- $g_1: f(1) = 1;$
- $g_2: f(2) = 2;$
- $g_3: f'(1) = 0;$
- $g_4: f'(1) = 0;$
- $\{g_1, g_2, g_3, g_4\}$
Solve: $\{a = 1, b = -3, c = 3, d = 0\}$
- $g(x) := \text{Substitute}[51, \text{Flatten}[\{56\}]]$
→ $g(x) := x^3 - 3x^2 + 3x$
-

The Graphics view shows a coordinate plane with the x-axis from -4 to 3 and the y-axis from -2 to 6. A cubic curve is plotted, passing through the origin (0,0), (1,1), and (2,2). The curve has a local maximum at (1,1) and a local minimum at (2,2).



1	Define the function $f(x) := ax^3 + bx^2 + cx + d$
2	The function value at 1 is 1: $g_1: f(1) = 1$; <u>Hint:</u> Use ":" to name your equation. The semicolon ";" suppresses the output.
3	The function value at 2 is 2: $g_2: f(2) = 2$;
4	The first derivative vanishes at 1: $g_3: f'(1) = 0$; <u>Hint:</u> The derivative of f can be written as f prime " f ".
5	The second derivative vanishes at 1: $g_4: f''(1) = 0$;
6	$x =$ Select rows two through five and apply the <i>Solve</i> tool. <u>Hint:</u> Press and hold the <i>CTRL</i> -key while clicking onto the row headers to select several rows concurrently. <u>Hint:</u> You can achieve the very same employing the <i>Solve</i> command: <code>Solve[{g_1, g_2, g_3, g_4}, {a, b, c, d}]</code>
7	Substitute the undefined variables in the formula of f to draw the function. To do so, drag the output of row six onto the definition of f in row one. <u>Hint:</u> To drag an object, click onto it, hold the mouse button down and move the cursor to the target location ahead of releasing it again.
8	 Turn on the visibility of the function in the new row.

Hint: You can also calculate the derivative of a function or term applying the *Derivative* tool. To integrate a function or term, deploy the *Integral* command or tool. Go ahead and try them out right now!

Challenge: In the last step you could also enter and evaluate $f(x)$ in a new row and drag the result from row six there. Other ways to substitute undefined variables are the *Substitute* command and the *Substitute* tool. Employ all three methods to draw f !

Challenge: You have come up with and drawn a solution. Is this solution unique?

7. Working with Matrices



Matrices are an important tool in mathematics and employed in various areas. Examples include the short and concise denotation of systems of linear equations as well as solving of the beforementioned. In this section you will learn how to unleash the power of matrix calculus in the *CAS View*.

An arbitrary fully determined system of independent linear equations, for example



$$\begin{aligned}2x + 3y + 2z &= 3 \\x + y + z &= 2 \\-y + 3z &= 7,\end{aligned}$$

can be written as a matrix multiplication, namely

$$\underbrace{\begin{pmatrix} 2 & 3 & 2 \\ 1 & 1 & 1 \\ 0 & -1 & 3 \end{pmatrix}}_A \cdot \underbrace{\begin{pmatrix} x \\ y \\ z \end{pmatrix}}_X = \underbrace{\begin{pmatrix} 3 \\ 2 \\ 7 \end{pmatrix}}_B.$$

In general, this permits us to consider the simple problem of solving the single matrix equation $A * X = B$ instead. This in turn can be achieved by multiplying with the inverse matrix of A from the left.

Preparations

- Open a new GeoGebra window.
- Switch to *Perspectives* –  *CAS & Graphics*.

Construction Steps

Finishing your construction, the *CAS View* will look like this:

	T
1	<pre>A := {{2, 3, 2}, {1, 1, 1}, {0, -1, 3}}</pre> $\rightarrow \mathbf{A} := \begin{pmatrix} 2 & 3 & 2 \\ 1 & 1 & 1 \\ 0 & -1 & 3 \end{pmatrix}$
2	<pre>B := {{3}, {2}, {7}}</pre> $\rightarrow \mathbf{B} := \begin{pmatrix} 3 \\ 2 \\ 7 \end{pmatrix}$
3	<pre>Invert[A] * B</pre> $\rightarrow \begin{pmatrix} 1 \\ -1 \\ 2 \end{pmatrix}$

1

Enter the coefficient matrix A as
$$A := \{\{2, 3, 2\}, \{1, 1, 1\}, \{0, -1, 3\}\}$$



2	Define the column vector B as $B := \{\{3\}, \{2\}, \{7\}\}$
3	Calculate the result via $\text{Invert}[A] * B$

Hint: Matrices are entered as a list of their rows from top to bottom. The rows themselves are provided as lists containing the actual values from left to right. Therefore the matrix $\begin{pmatrix} a & b \\ c & d \end{pmatrix}$ is given as $\{\{a, b\}, \{c, d\}\}$.

Challenge

Solve the following system of equations using matrices in the *CAS View*:

$$\begin{aligned} ax + 2y &= c \\ -\sqrt{2}y &= 2a. \end{aligned}$$